

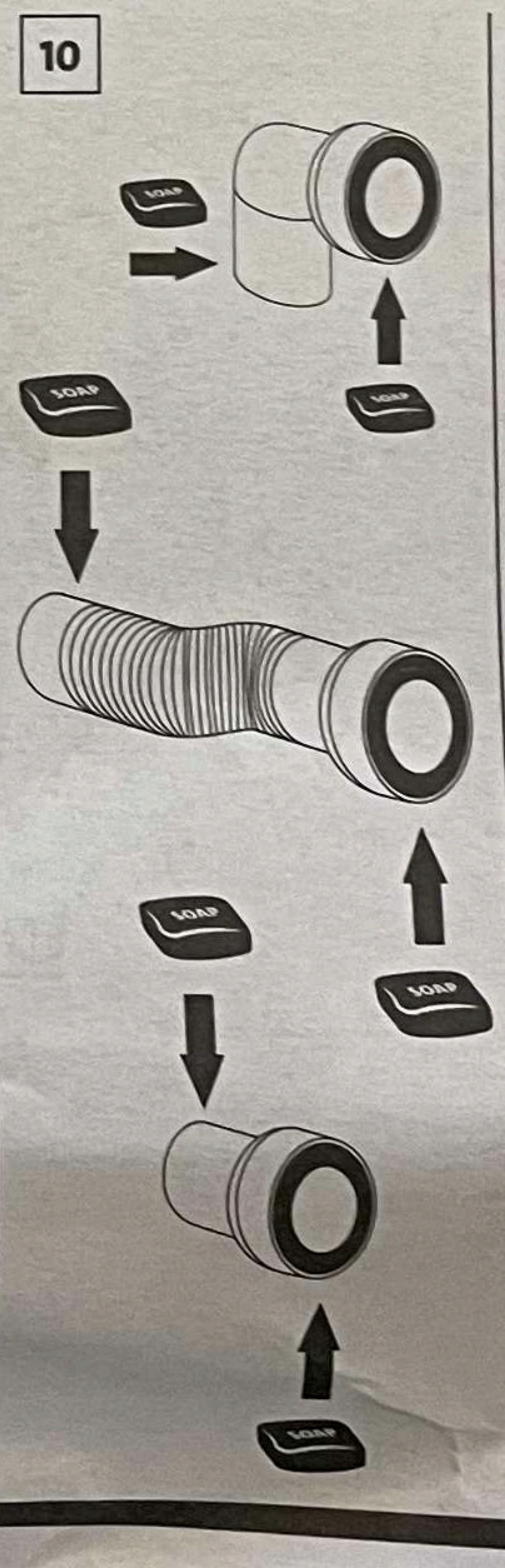

30-0503-0298

- PL** INSTRUKCJA MONTAŻU I EKSPLOATACJI
- SK** NÁVOD NA MONTÁŽ A ÚDRŽBU
- DE** MONTAGE- UND AUFBAUANLEITUNG
- EN** INSTRUCTIONS FOR ASSEMBLY AND USE
- FR** INSTALLATION ET UTILISATION – MODE D'EMPLOI
- EST** PAIGALDUS-JA KASUTUSJUHEND
- HU** SZERELÉSI ÉS ÜZEMELTETÉSI ÚTMUTATÓ
- LT** MONTAVIMO IR EKSPLOATAVIMO INSTRUKCIJA
- LV** MONTĀŽAS UN EKSPLUATĀCIJAS INSTRUKCIJA
- RO** INSTRUCȚIUNI DE MONTAJ ȘI OPERARE
- RU** ИНСТРУКЦИЯ ПО МОНТАЖУ И ЭКСПЛУАТАЦИИ
- CZ** NÁVOD NA MONTÁŽ A ÚDRŽBU
- UA** ІНСТРУКЦІЯ З МОНТАЖУ І ЕКСПЛУАТАЦІЇ
- BY** ІНСТРУКЦЫЯ ПА МАНТАЖЫ І ЭКСПЛУАТАЦЫІ

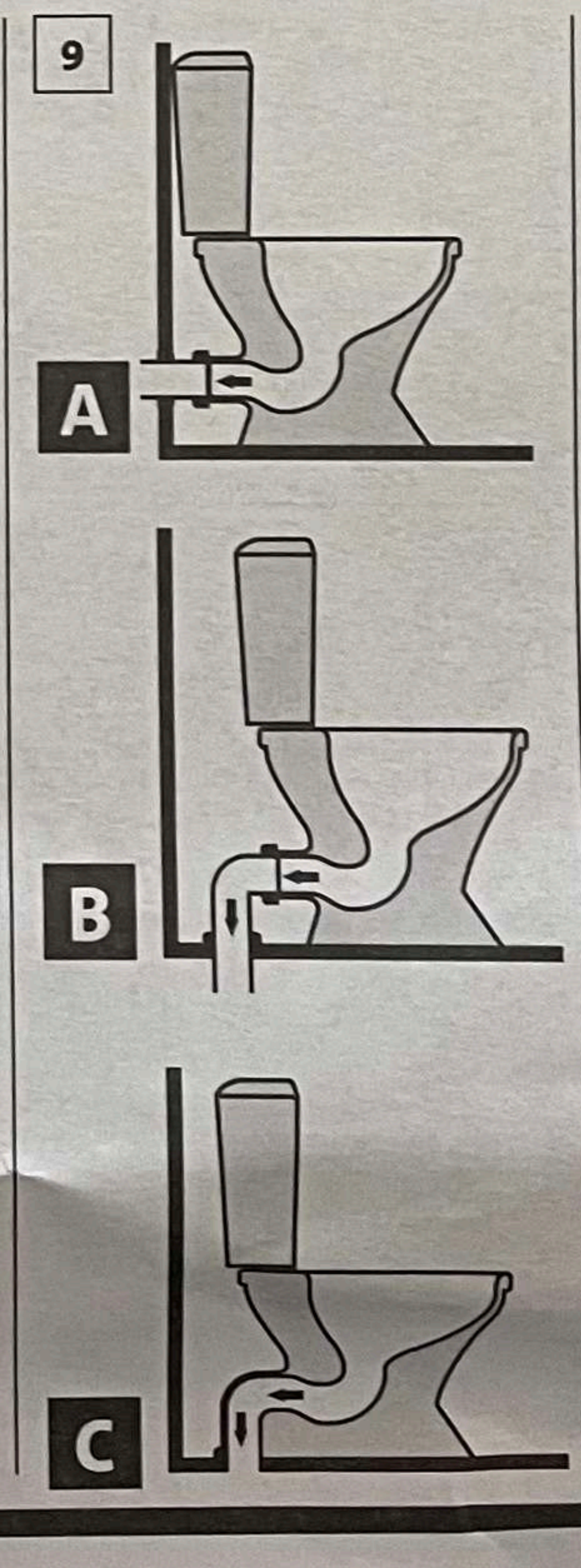
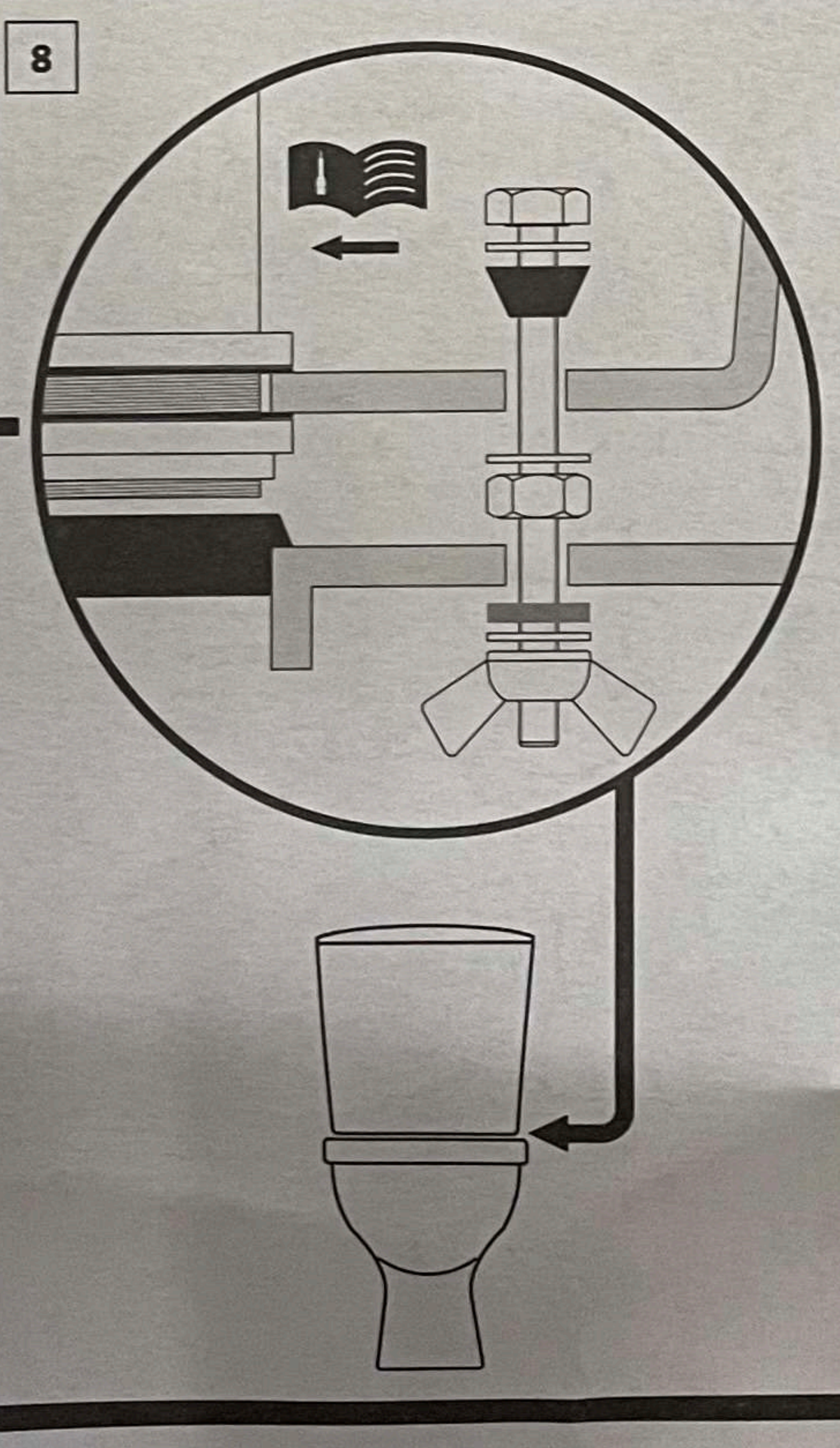
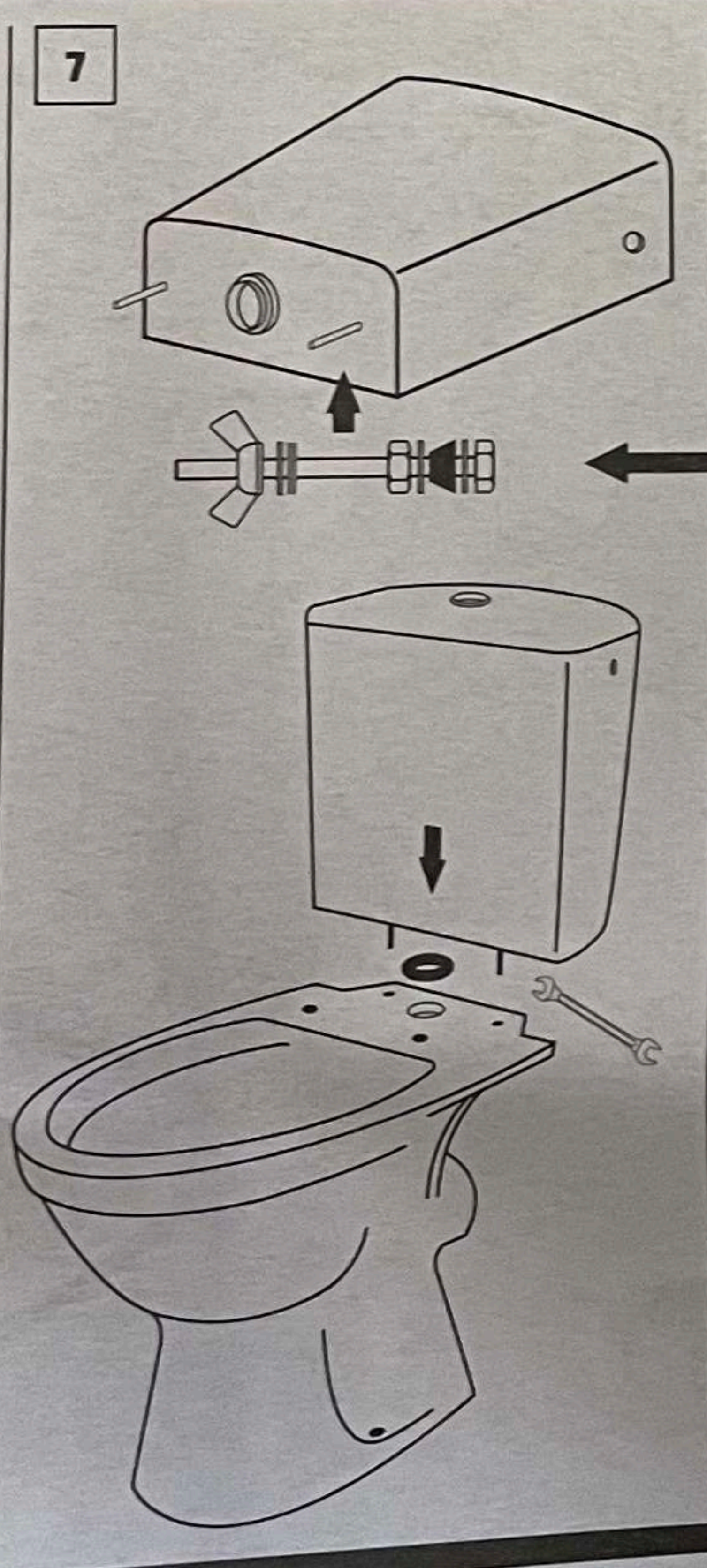
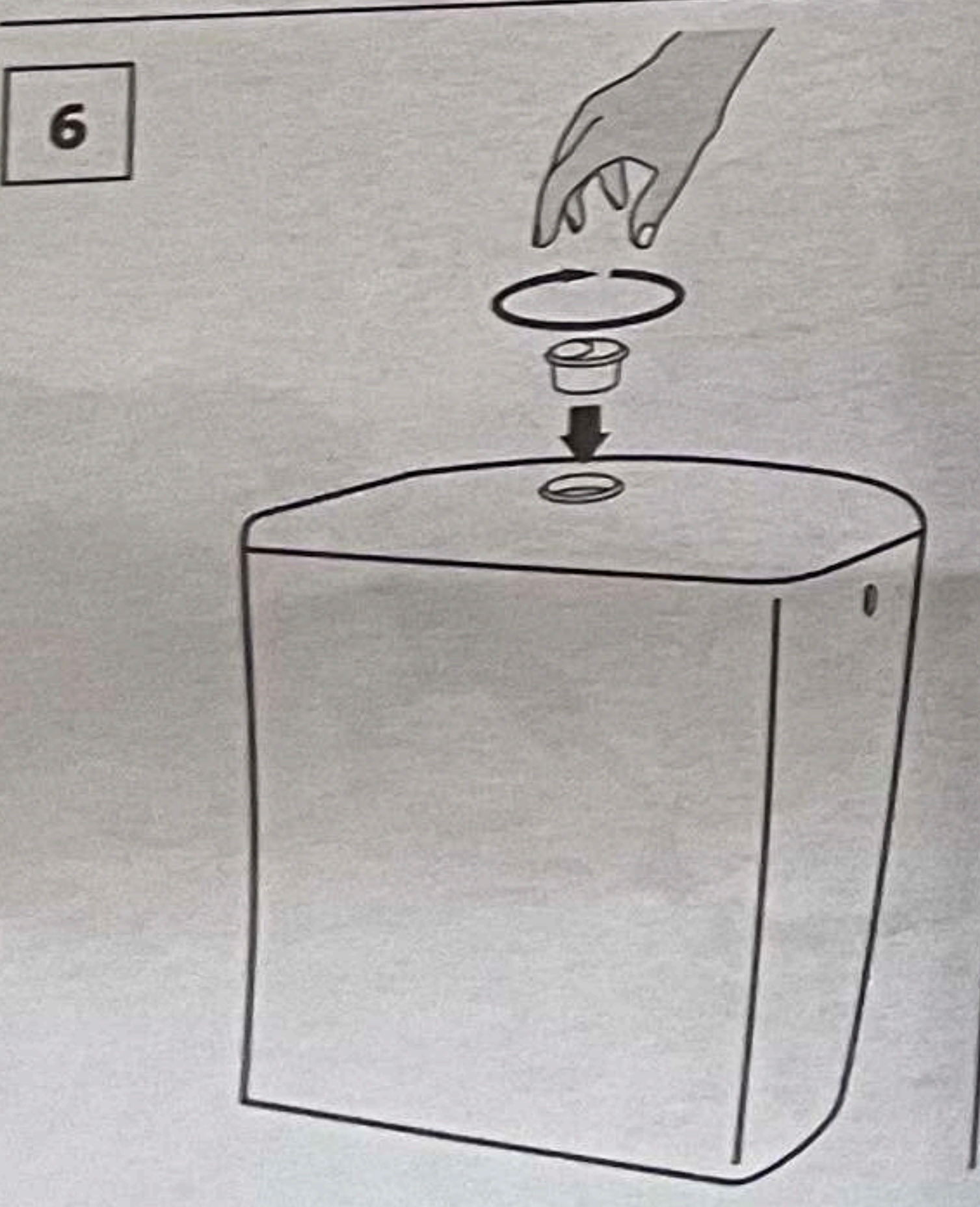
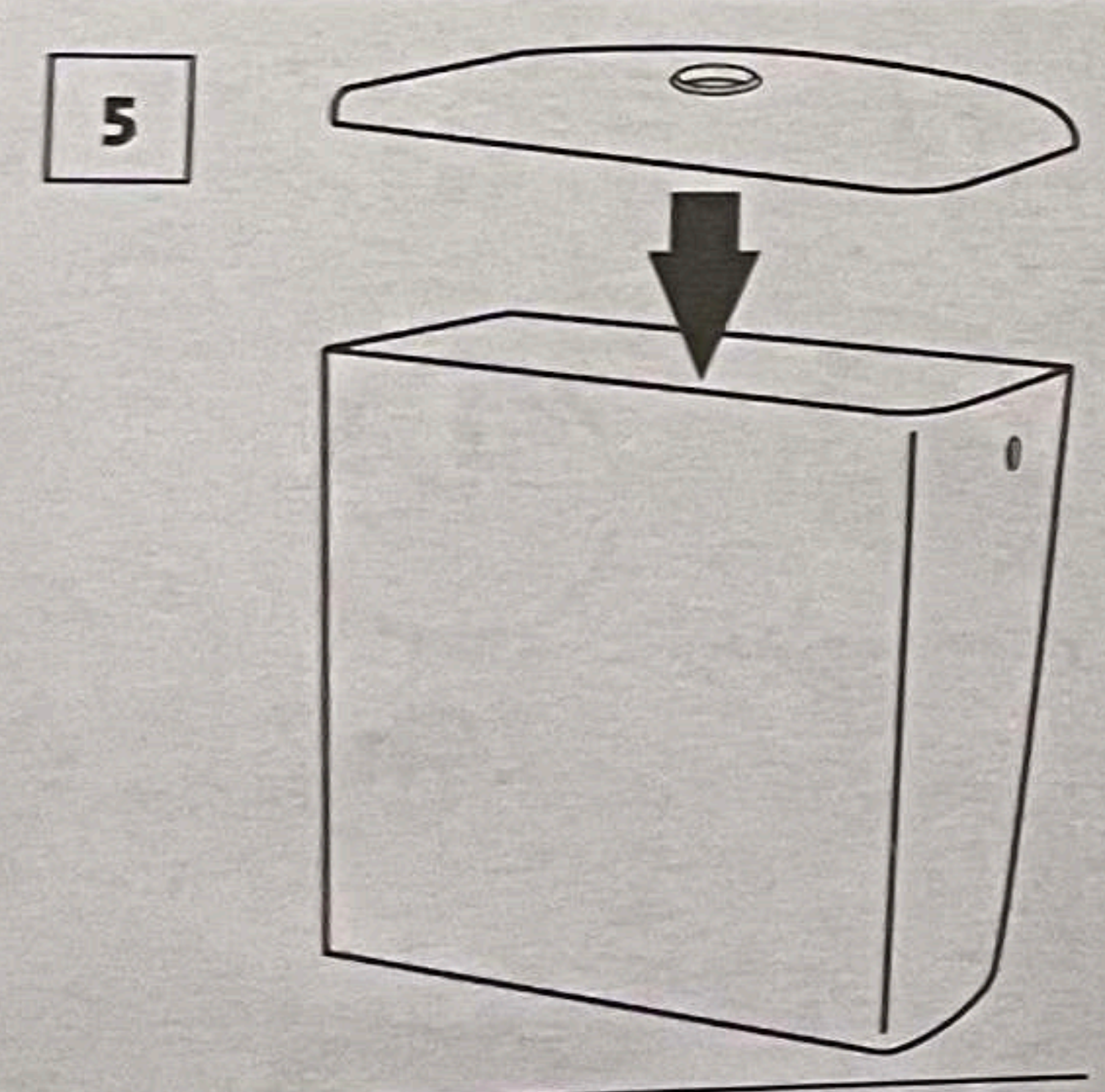
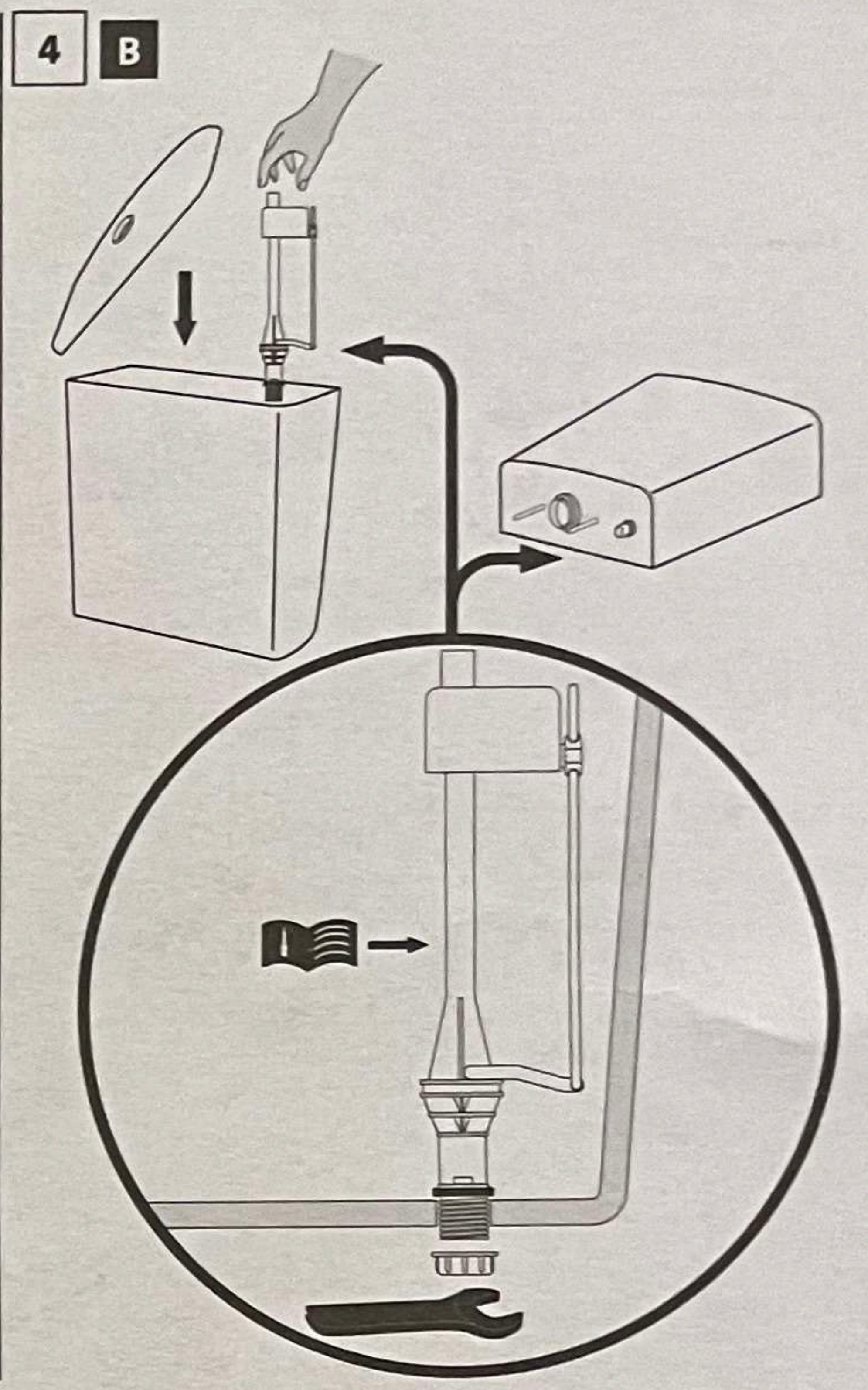
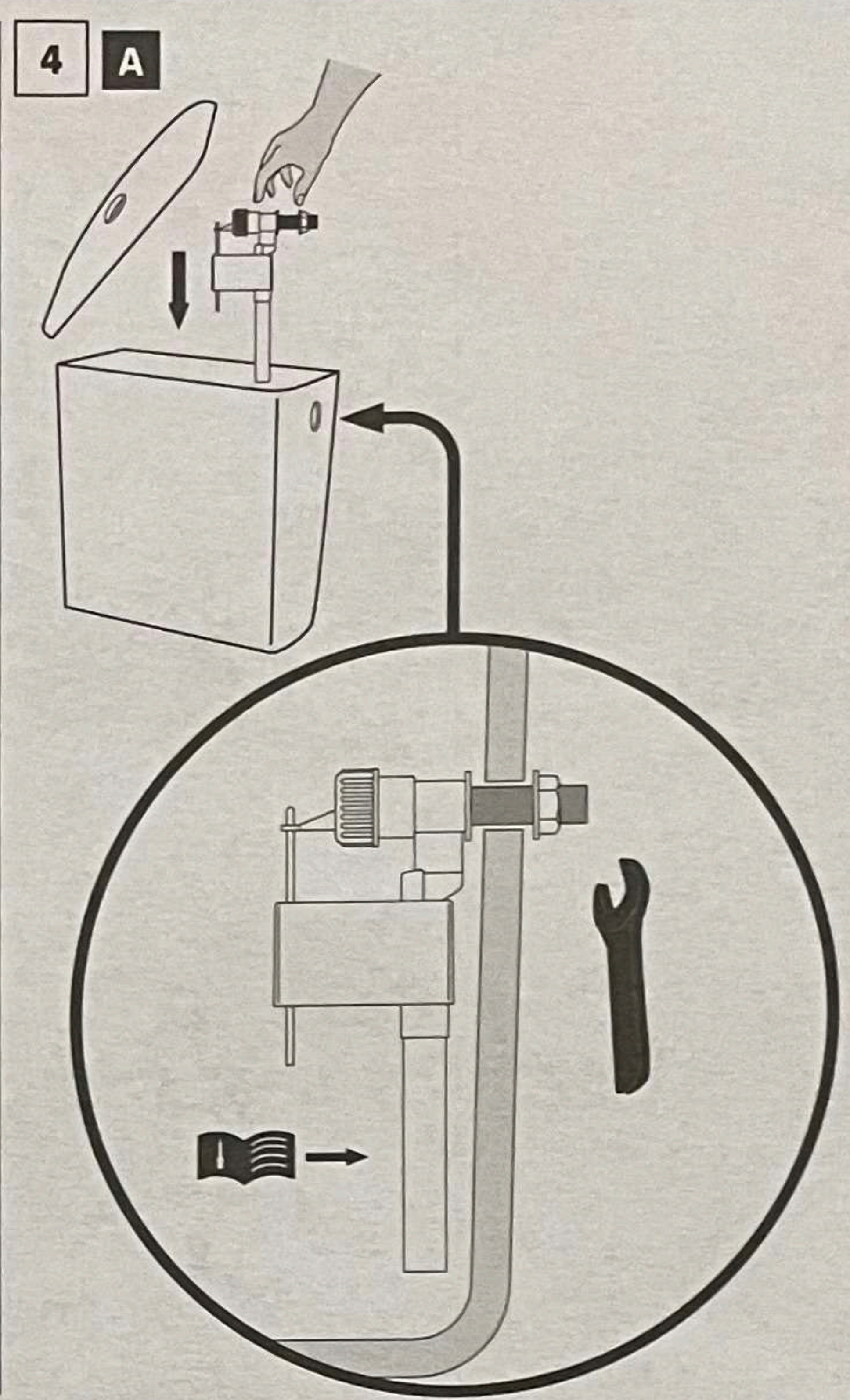
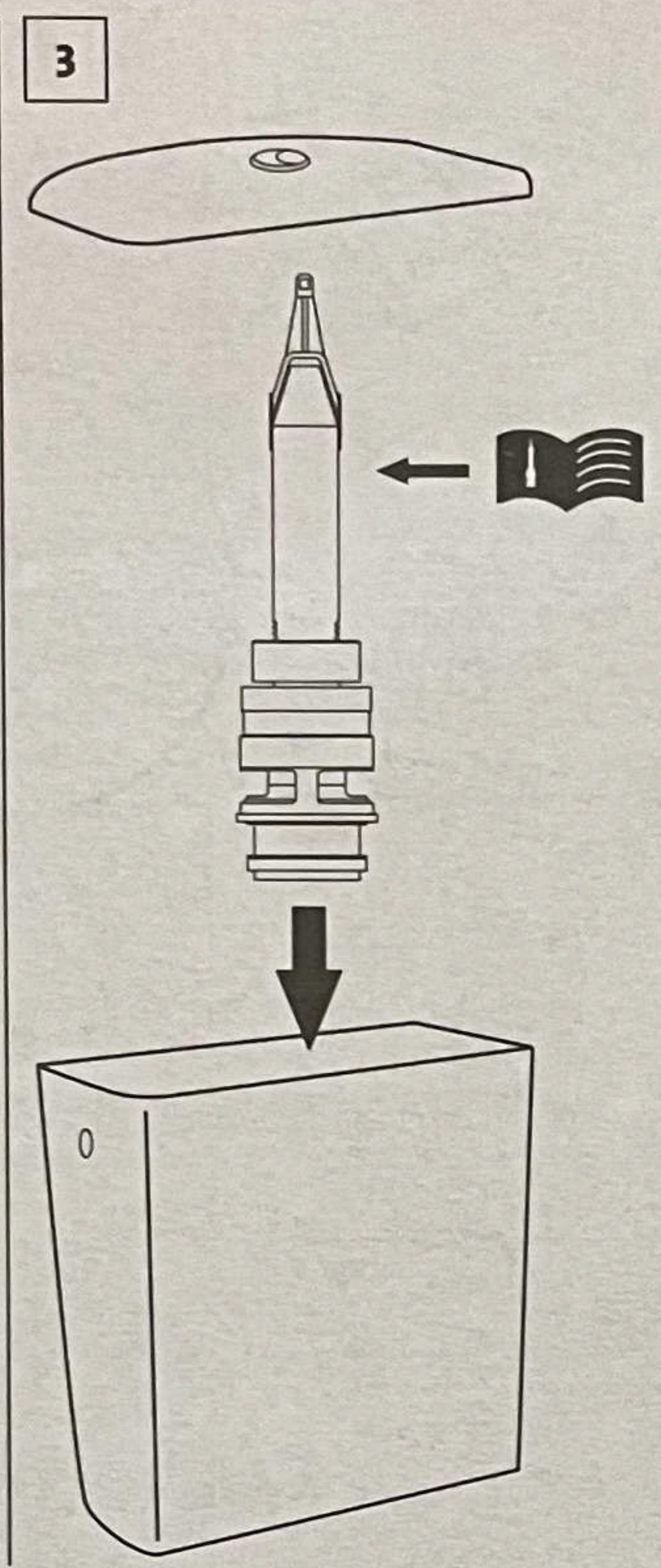
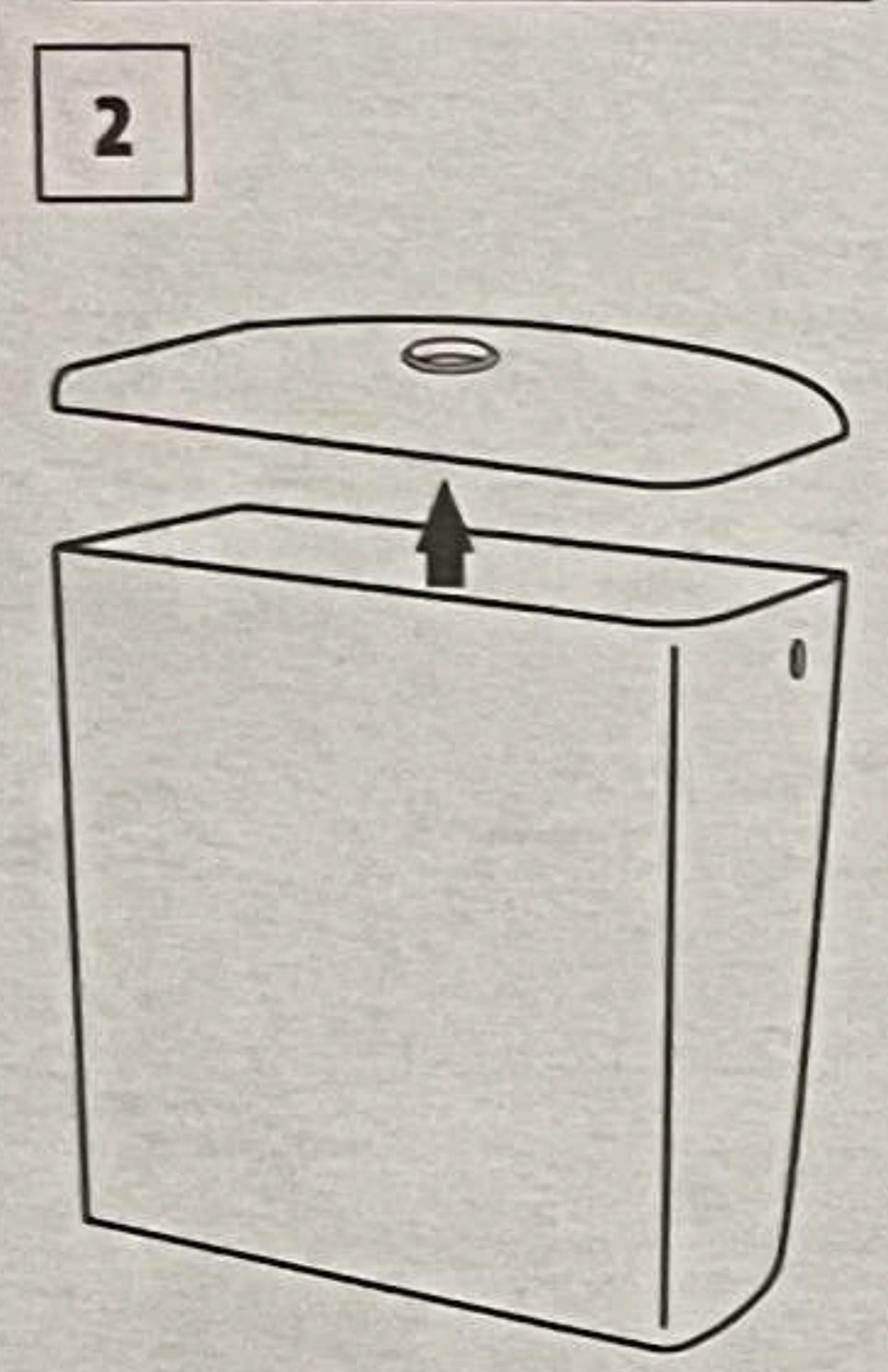
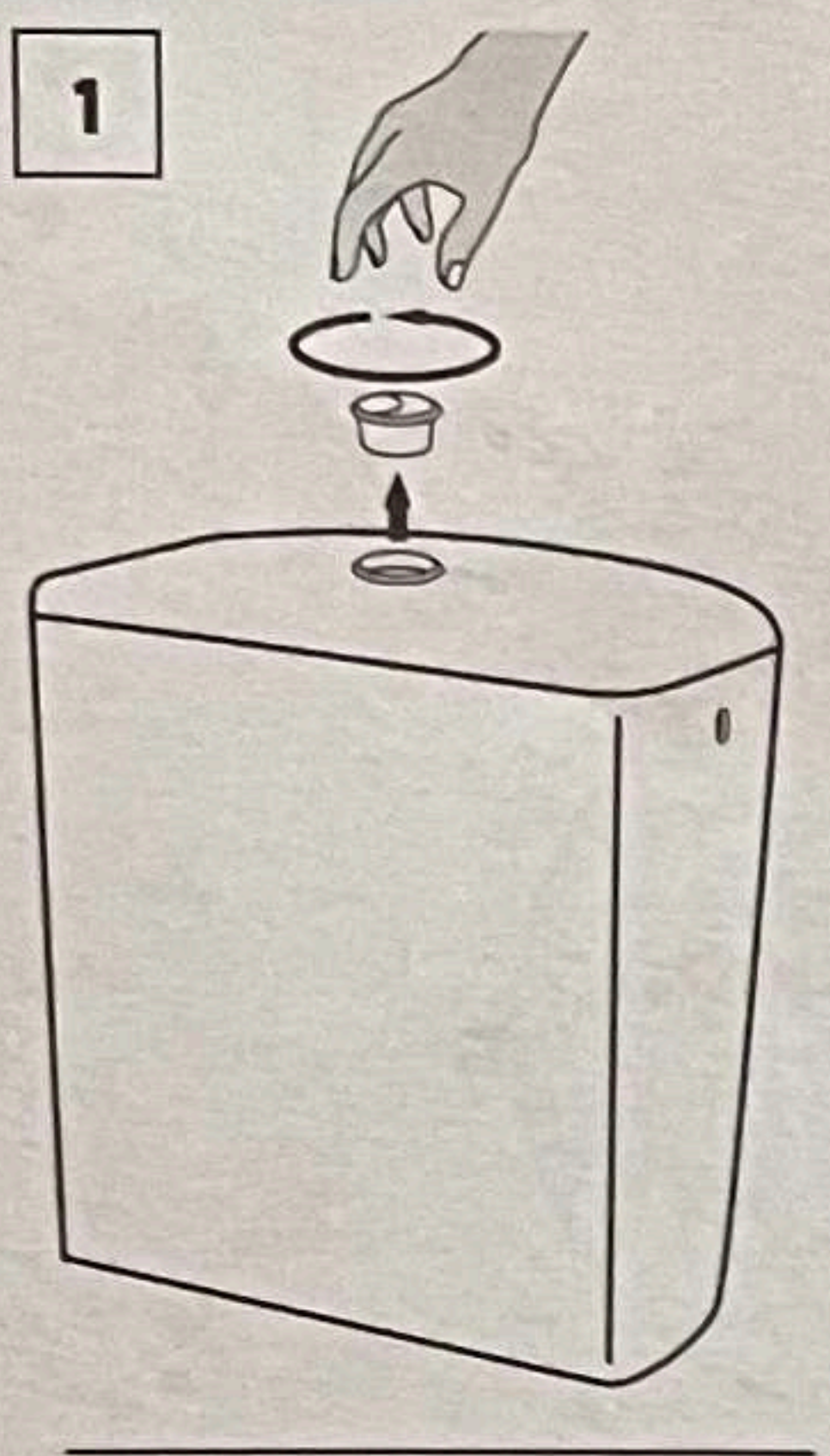
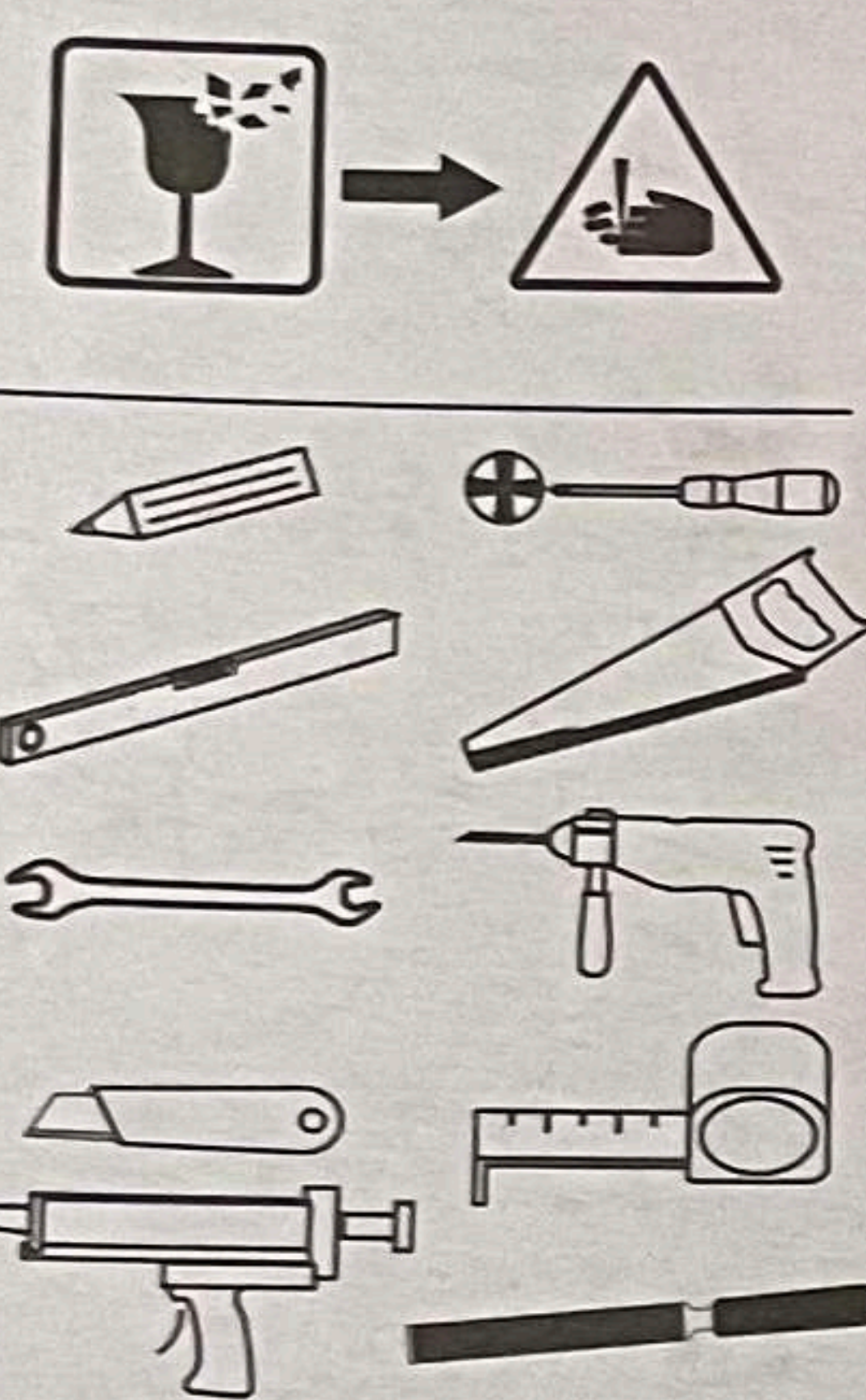

11

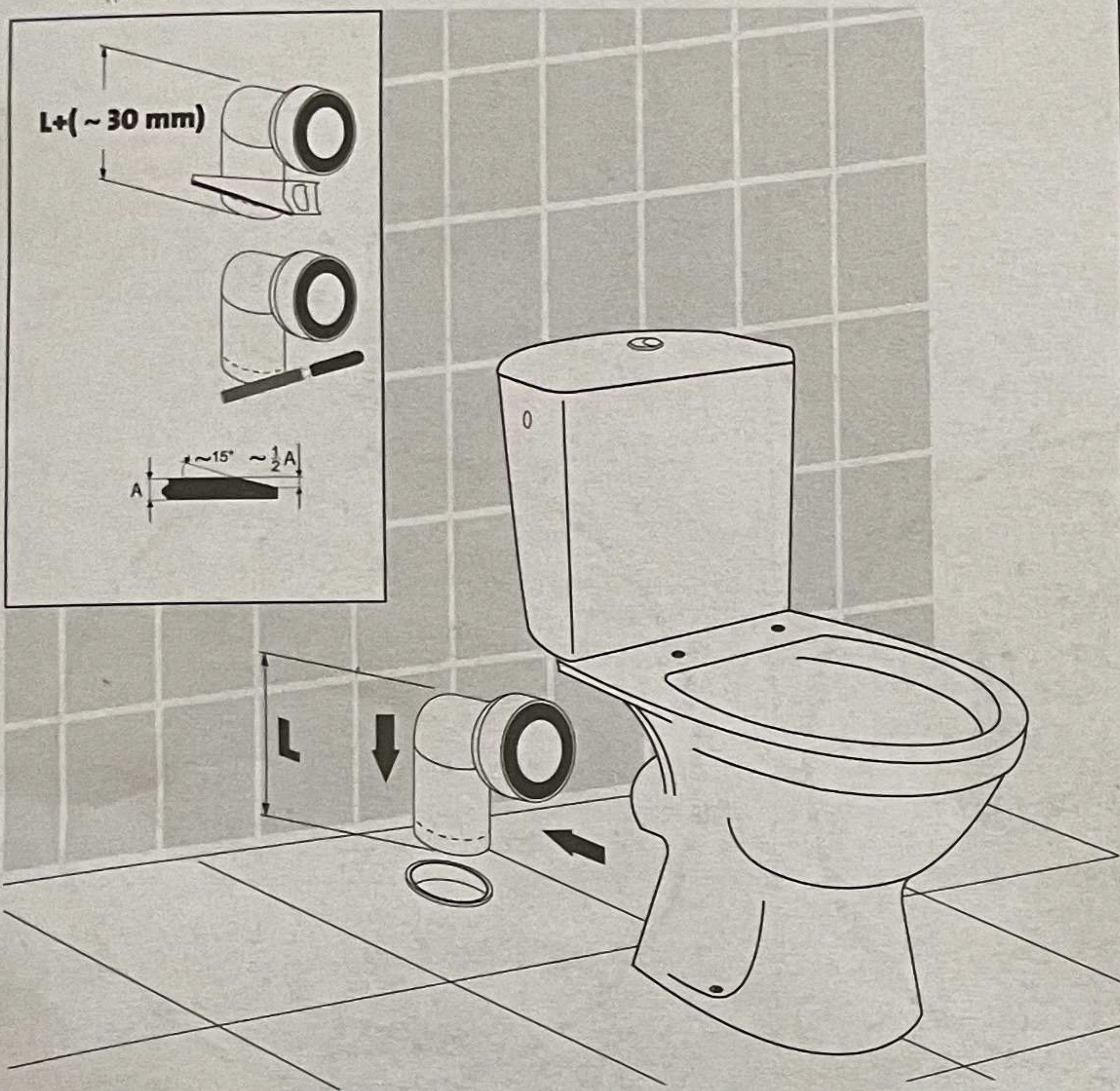

11



12 A

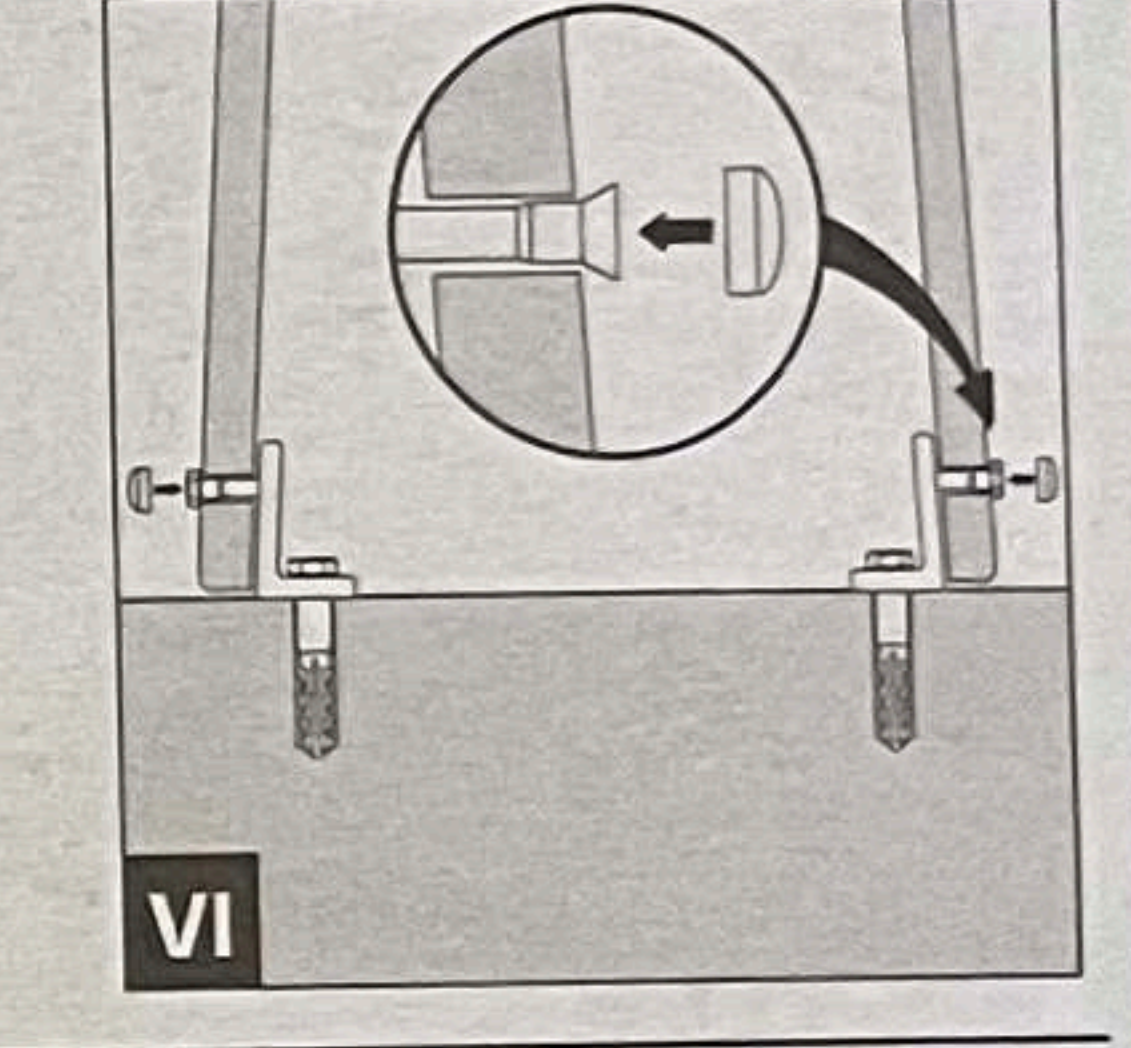
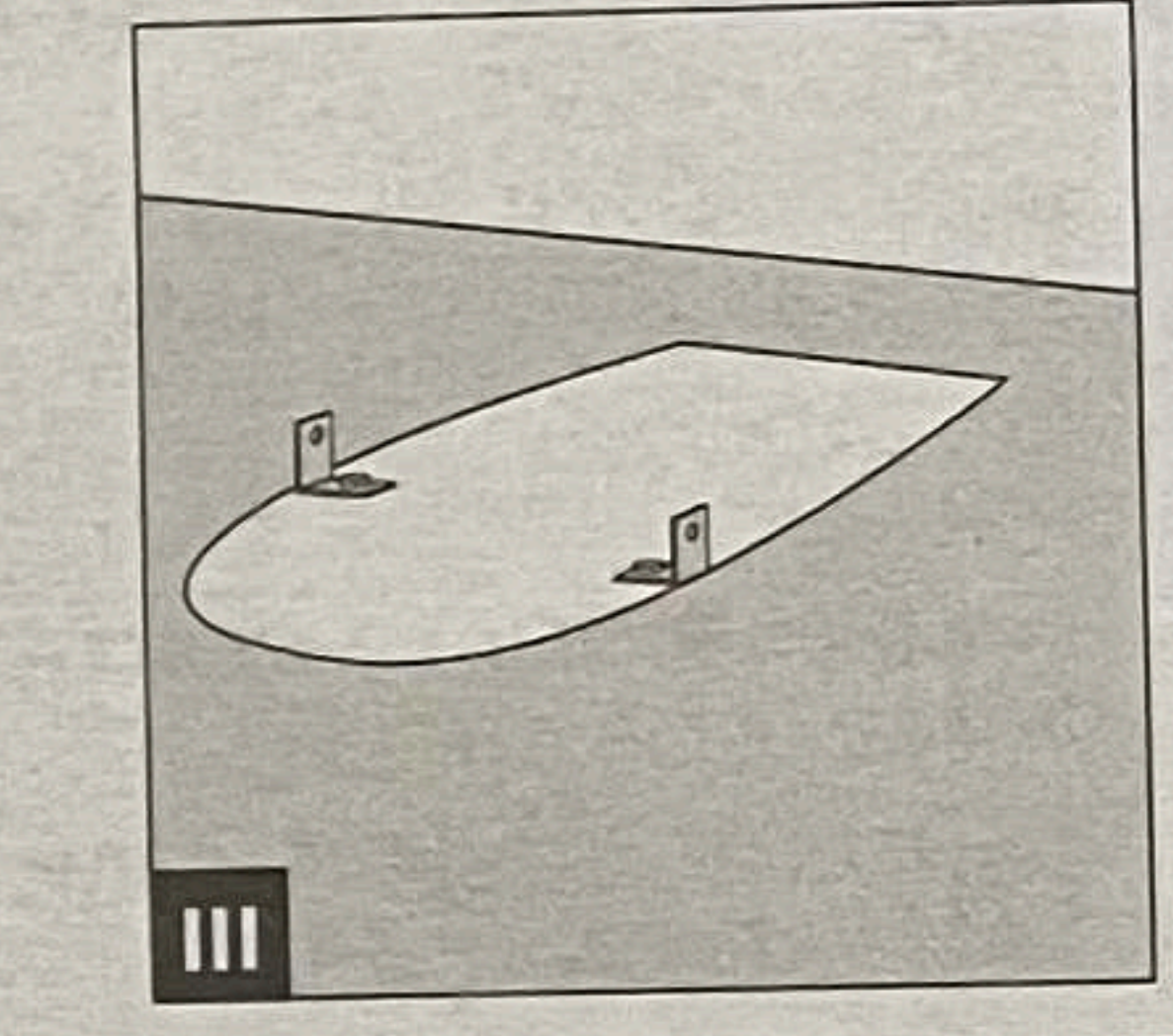
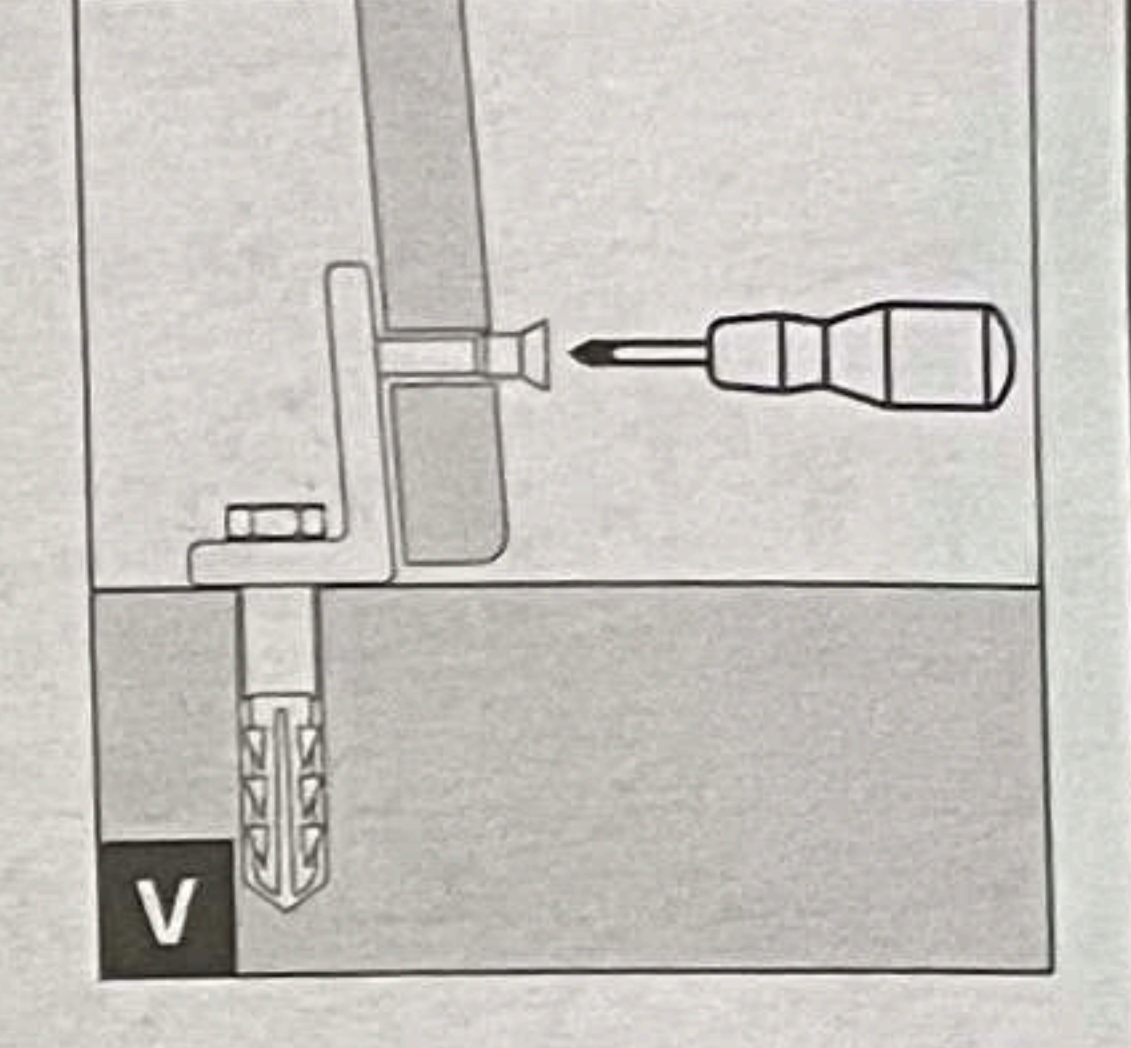
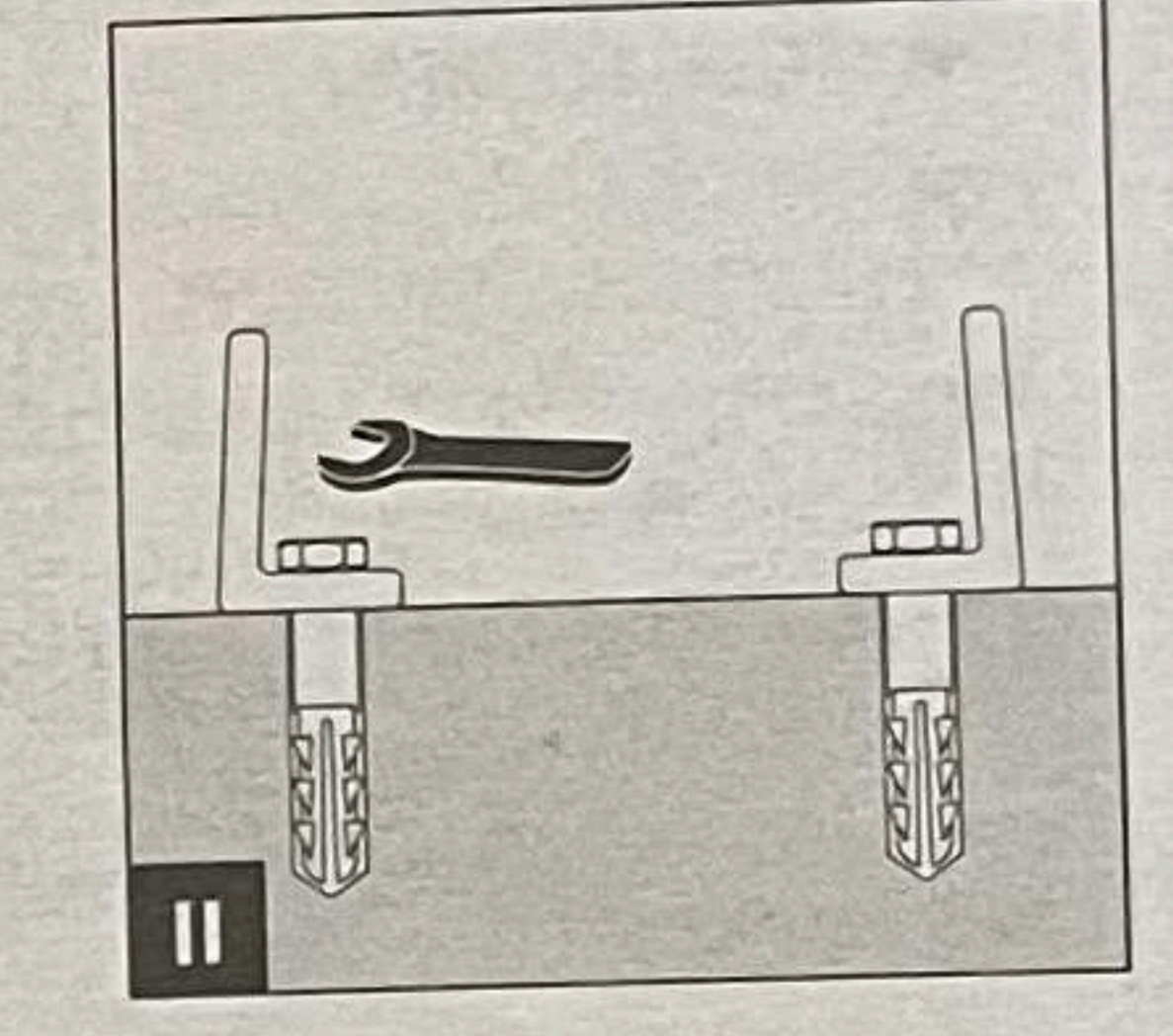
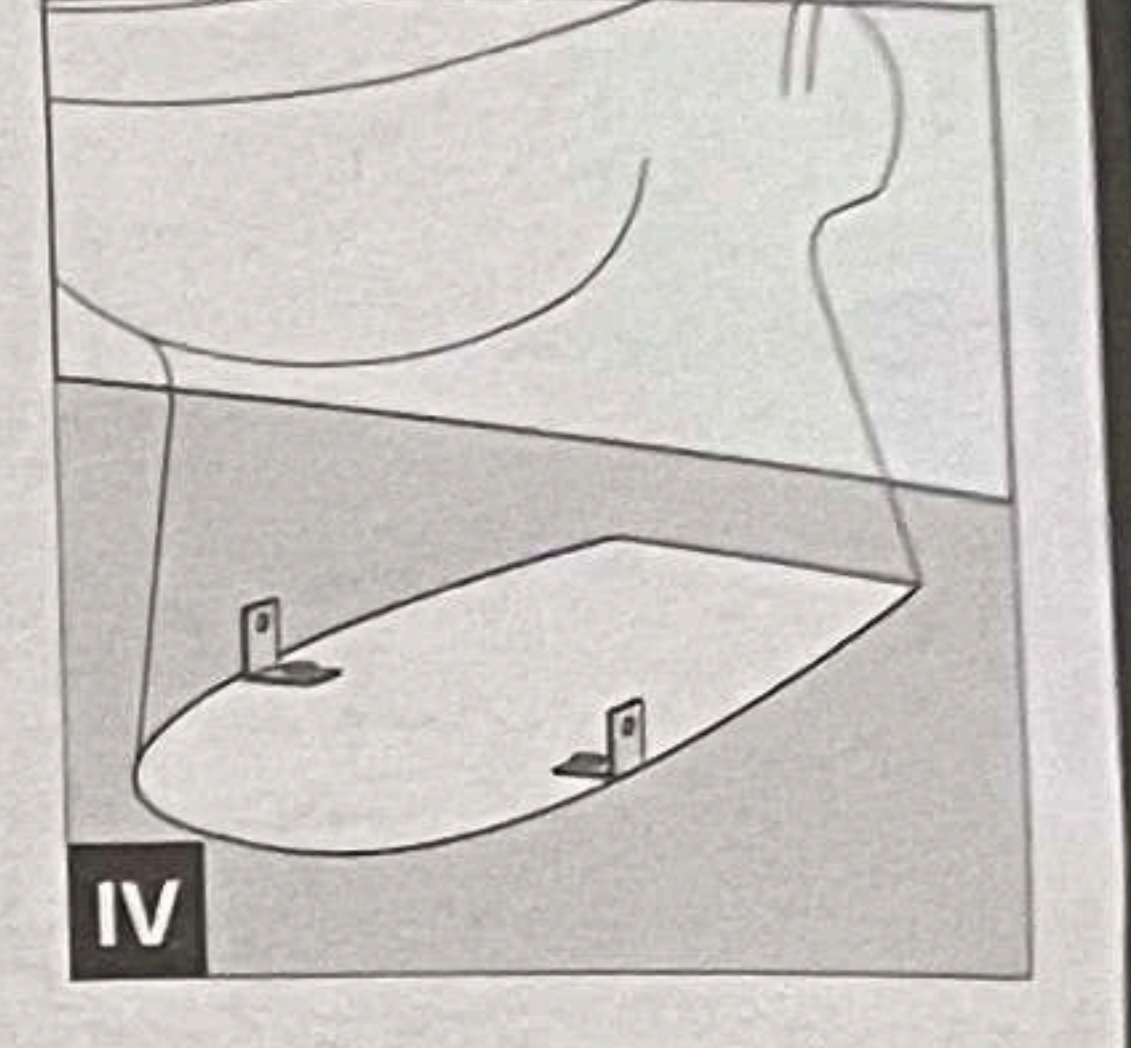
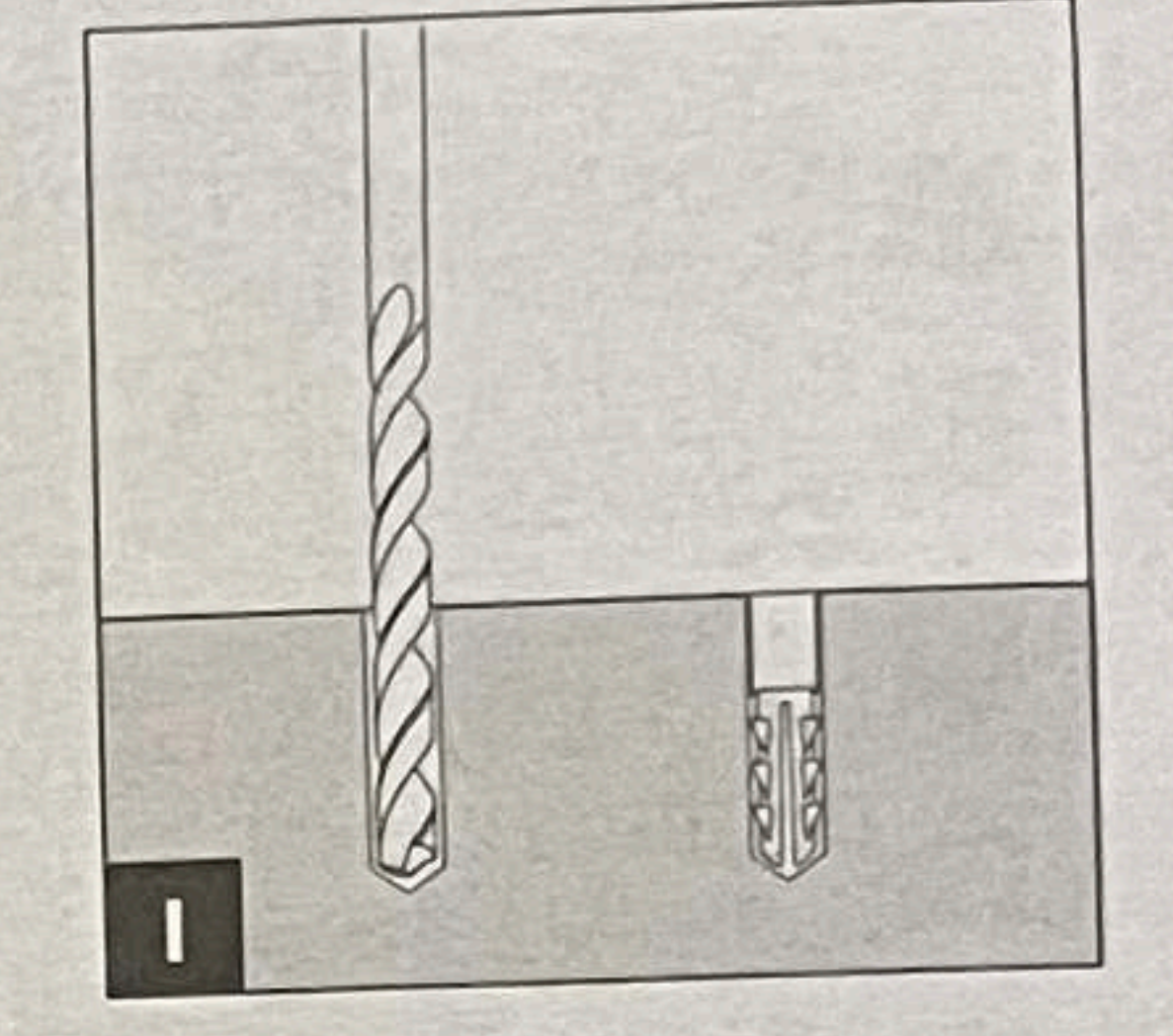
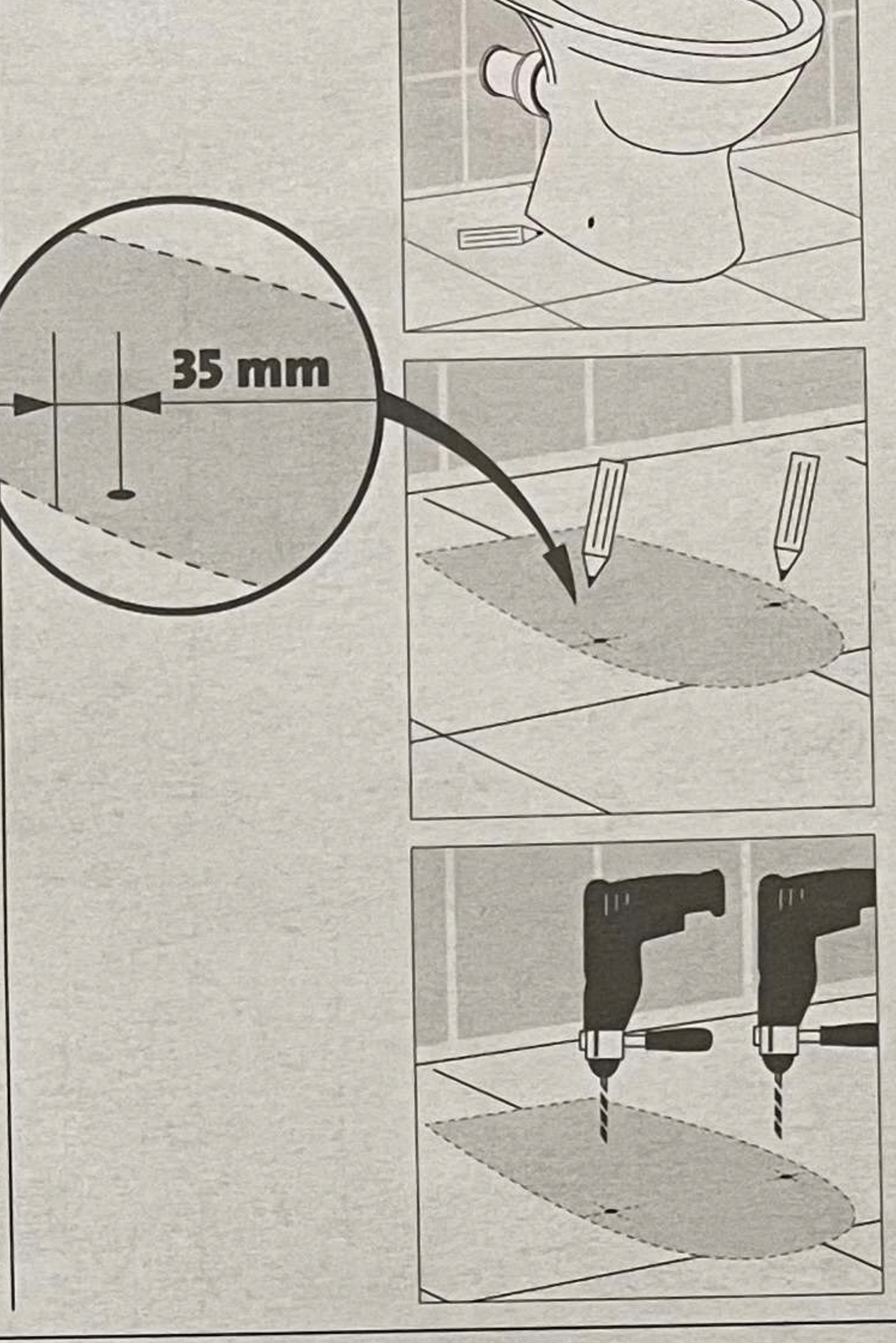

12 B

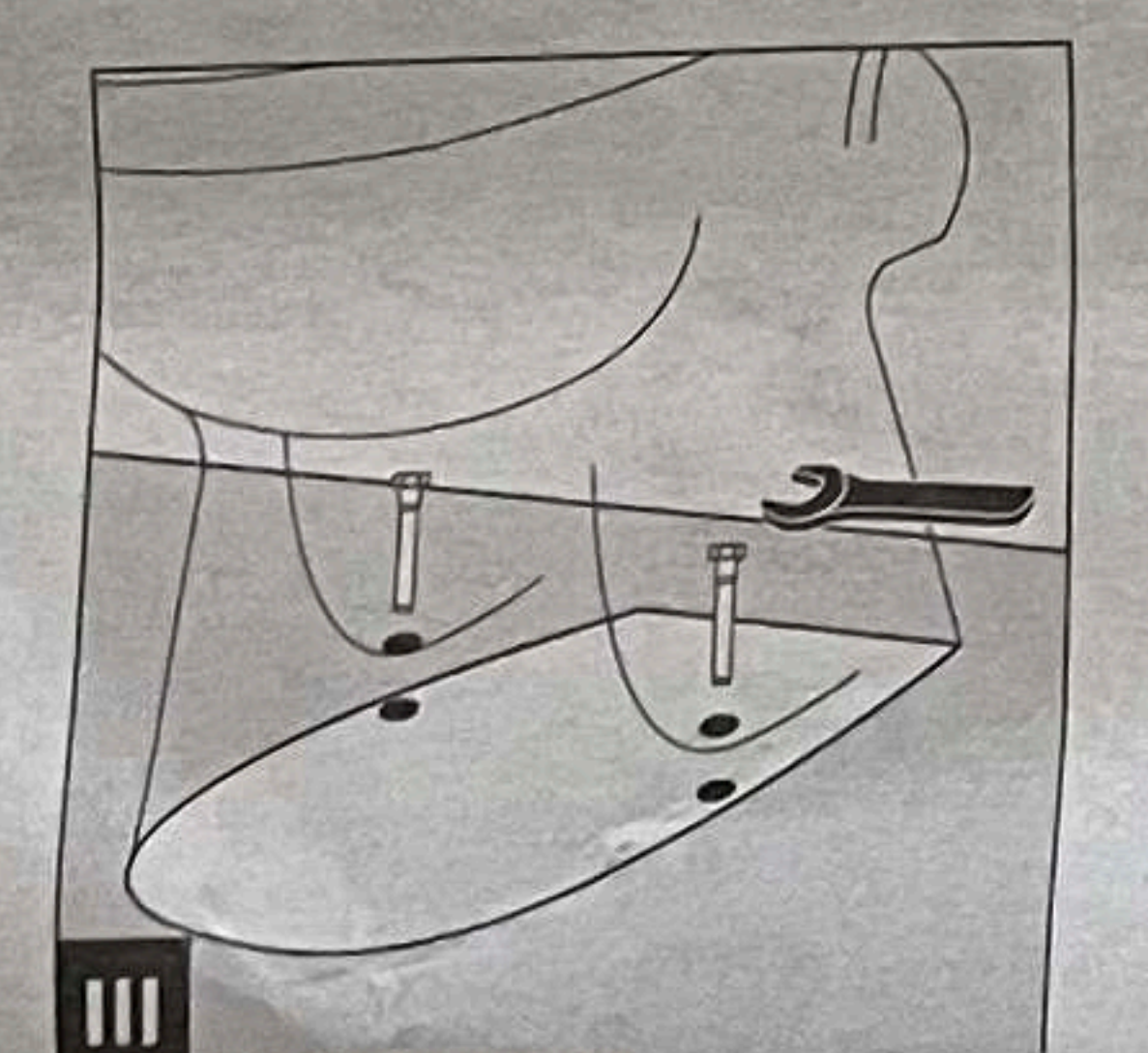
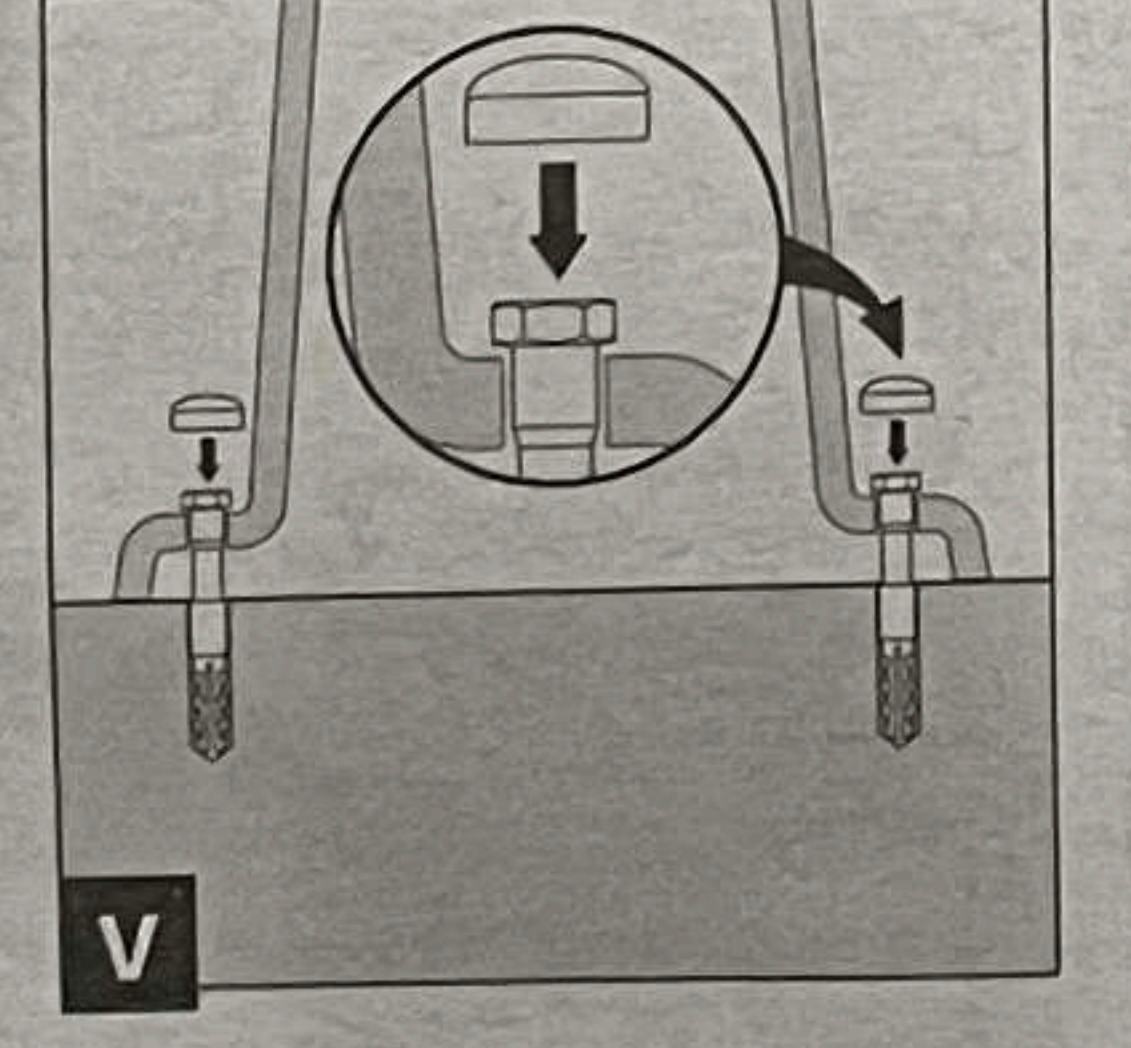
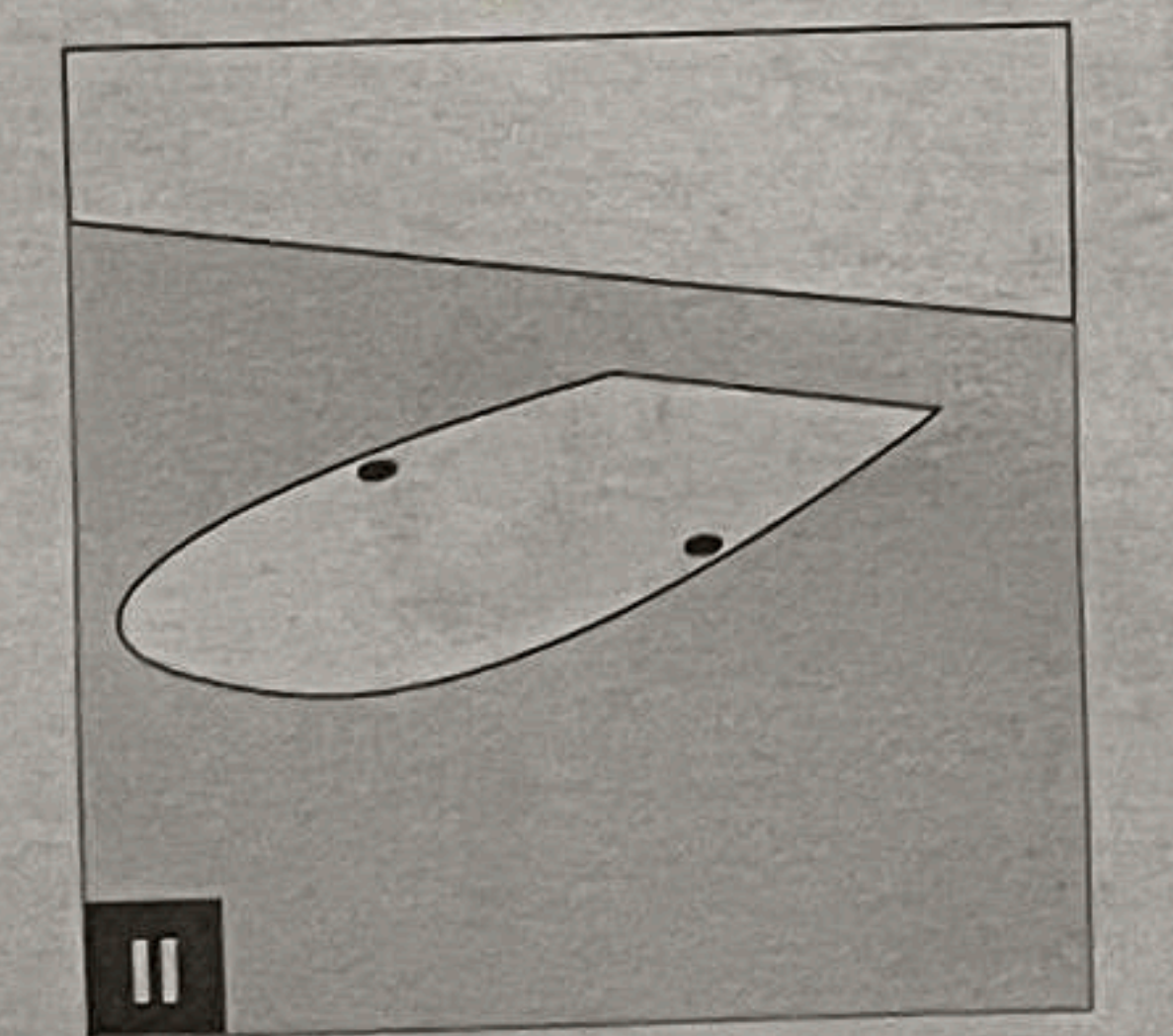
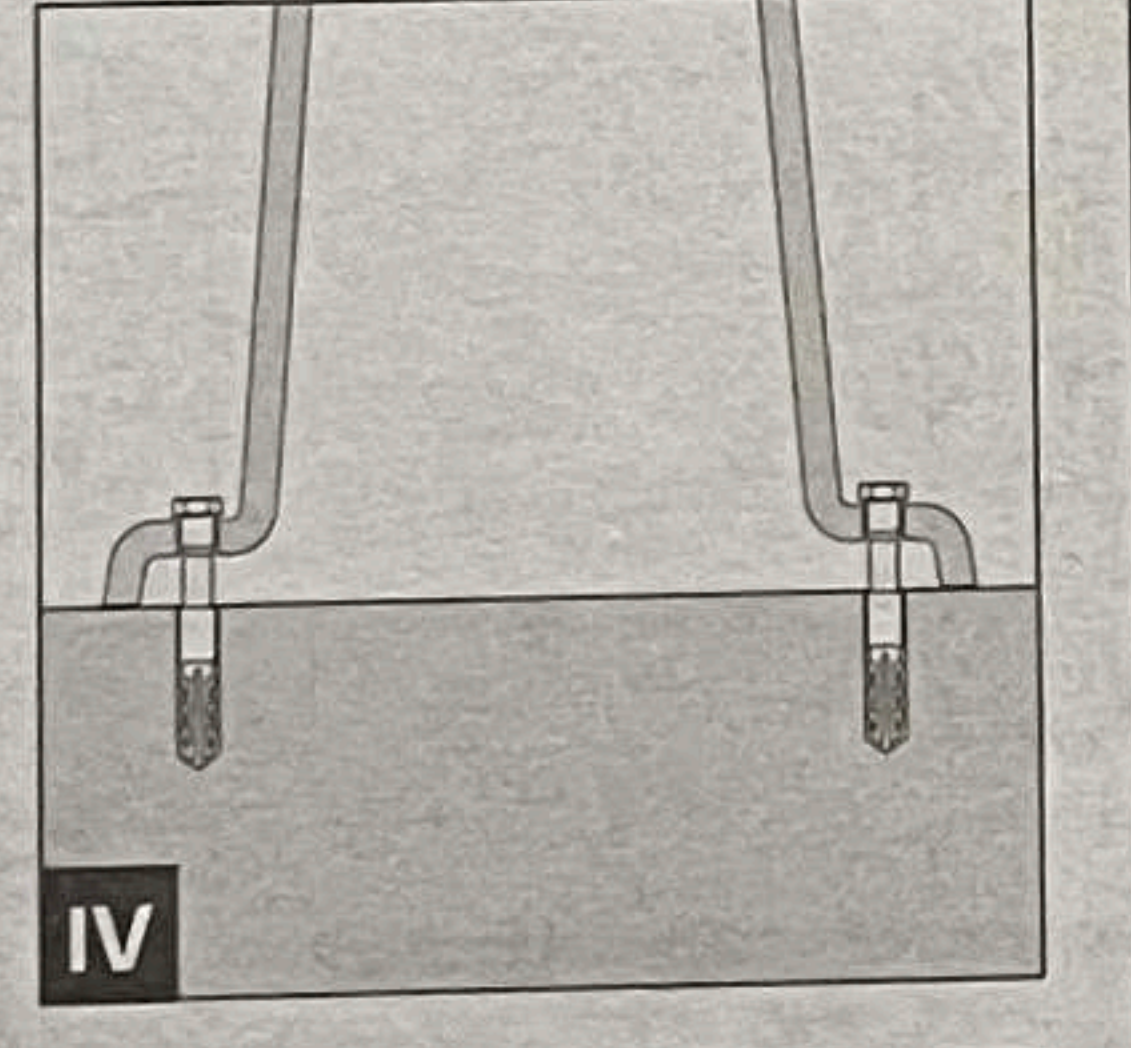
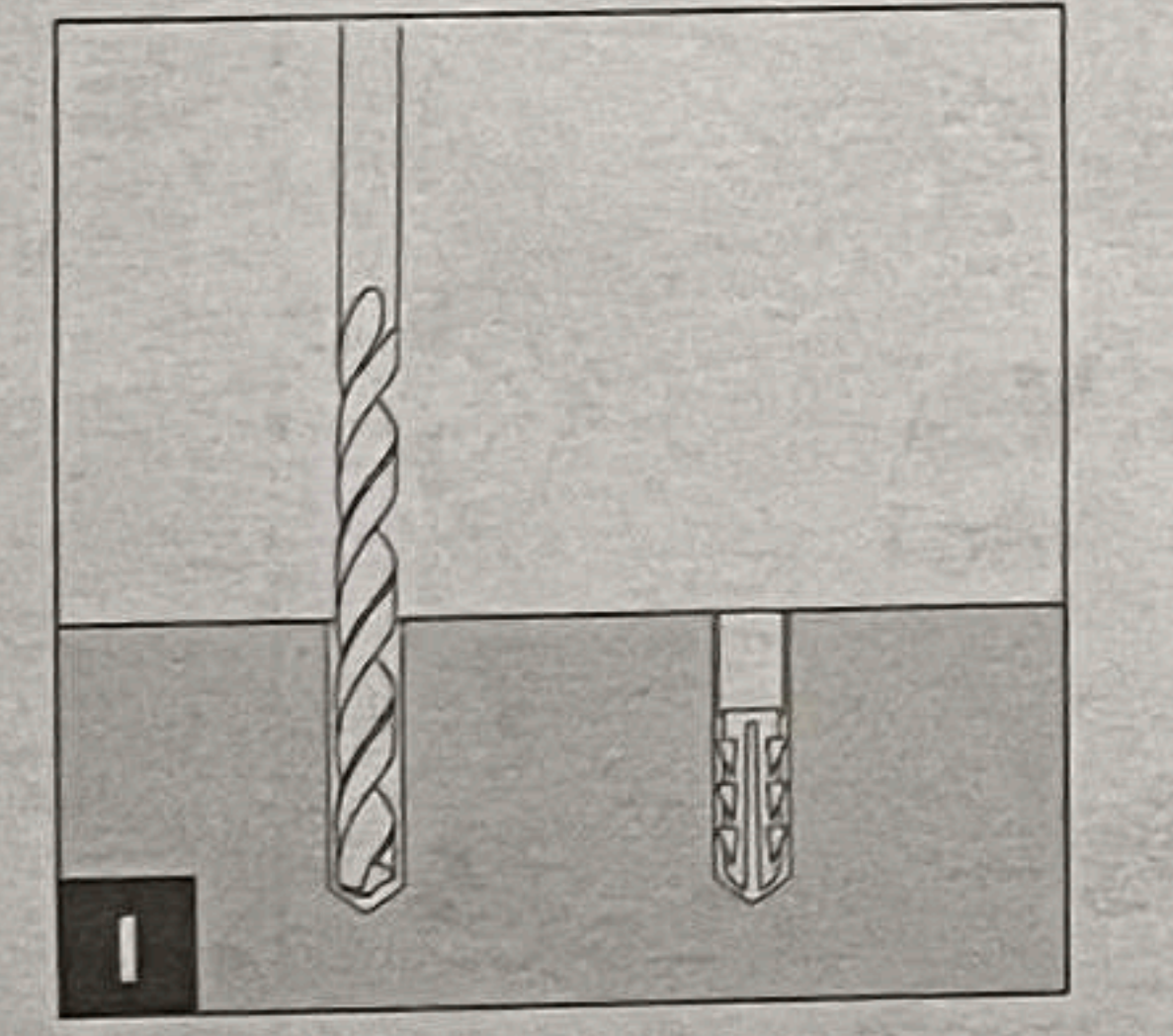
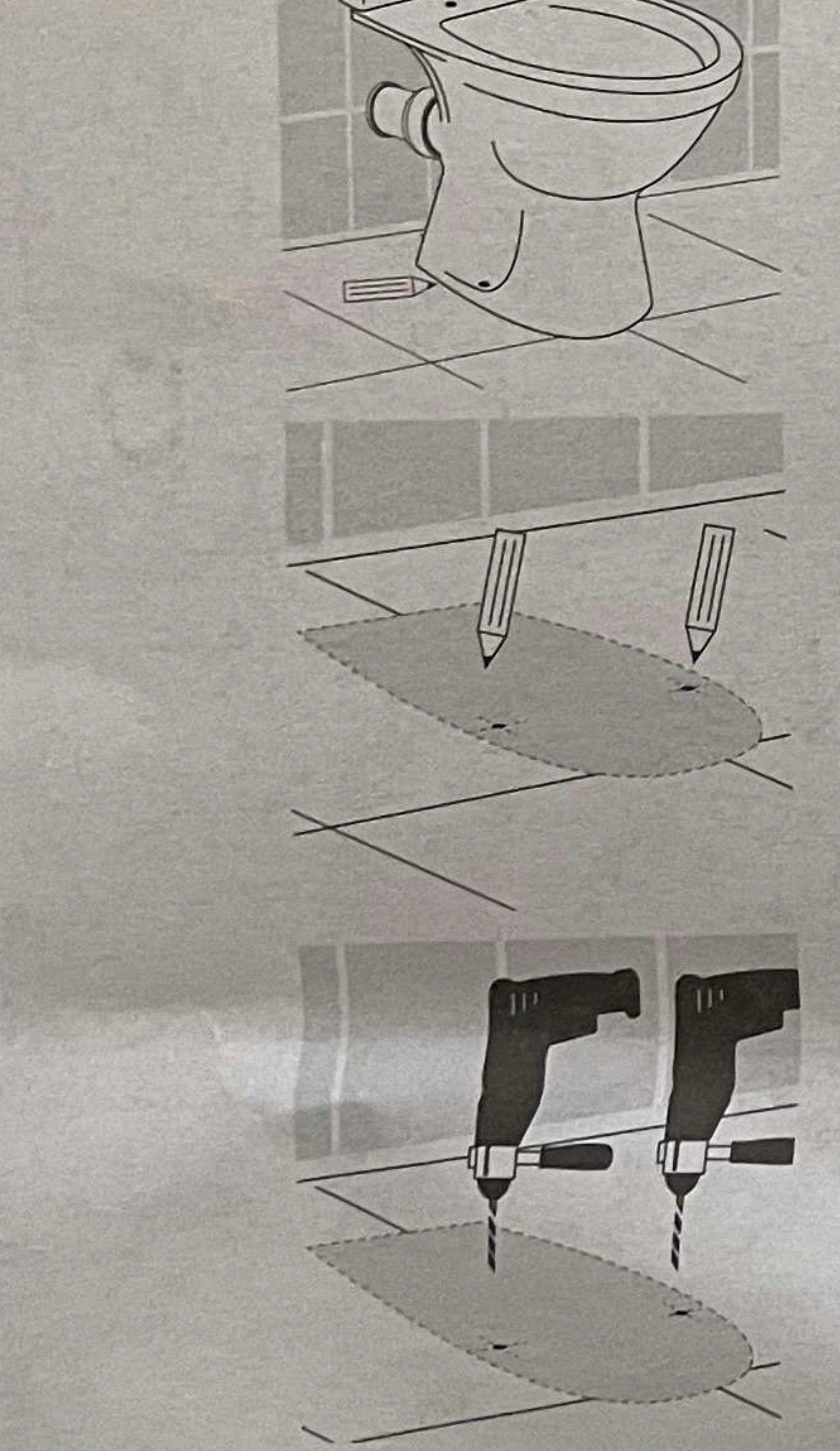

13 A

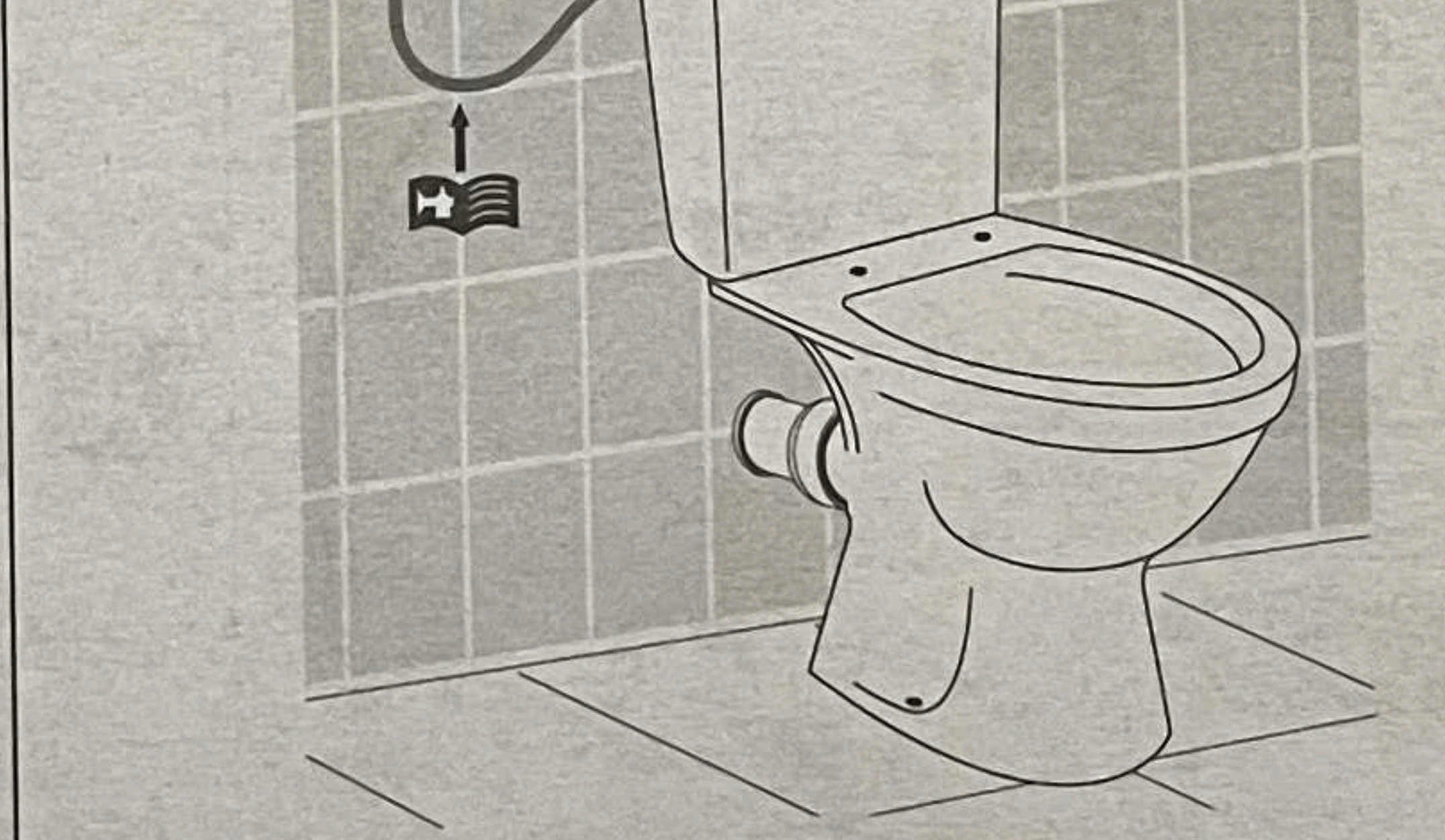

B

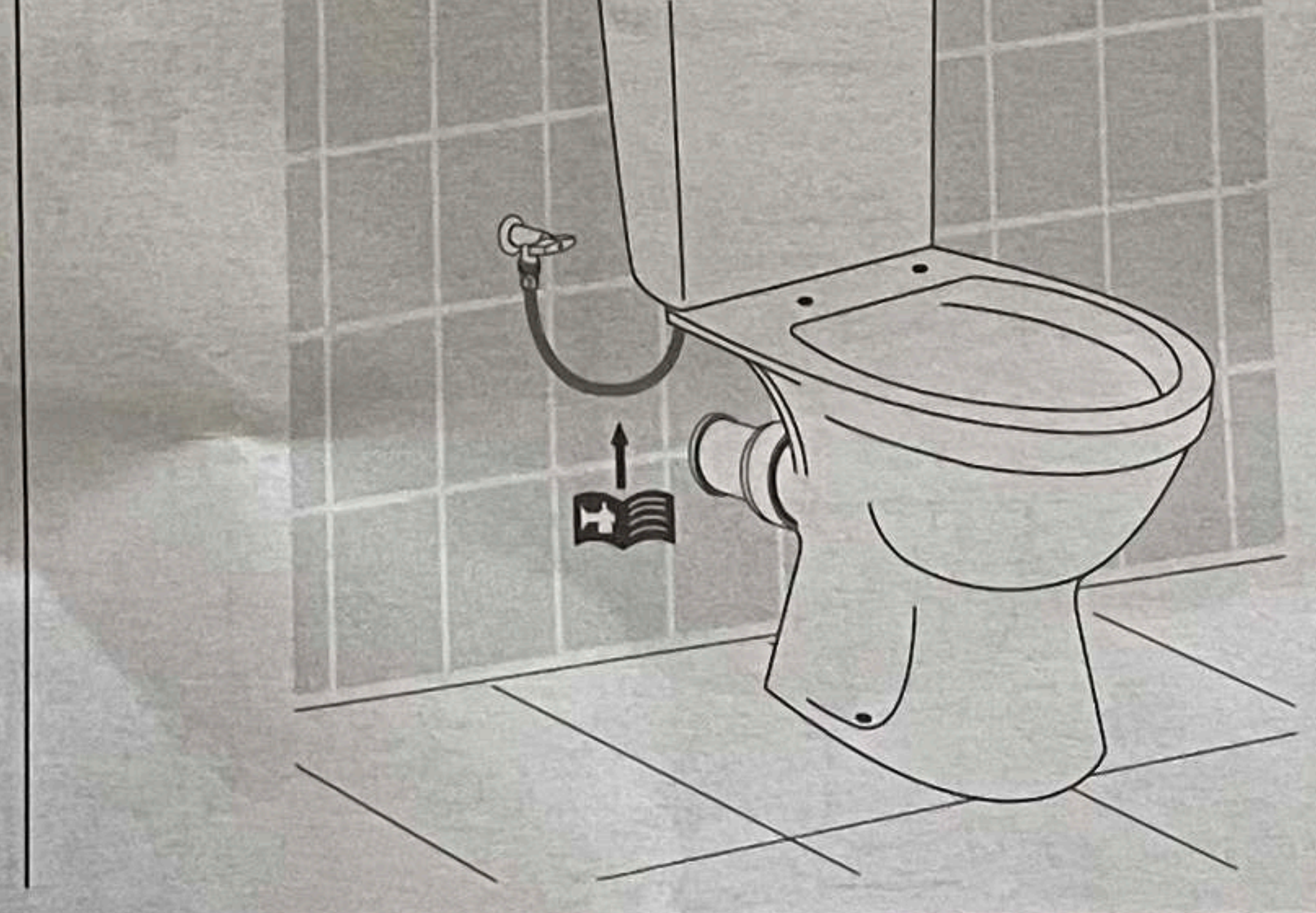

14

