

COLLECTION  
2019



Occupez-vous de vos fesses !

 Société française



Présentation	P.1
Abattants WC japonais	P.2
WC japonais au sol	P.8
WC japonais suspendus	P.14
Kit Douchette hygiène WC	P.31
Adaptabilité	P.35
Légende	P.36

# Sommaire

# Présentation



Au cours des siècles, nous avons considérablement amélioré notre niveau d'hygiène corporelle.

La plupart des européens prennent aujourd'hui une douche quotidienne.

**Seule notre hygiène intime n'a quasiment pas évoluée !**

Dès son apparition sur terre, l'homme s'essuyait avec des feuilles ou de la mousse qu'il avait ramassé dans la nature. Aujourd'hui, nous utilisons exactement la même méthode, seuls les matières utilisées pour s'essuyer et les lieux pour le faire ont évolués.

S'essuyer n'est pourtant pas la solution la plus hygiénique ni la plus bénéfique pour notre organisme ...

Ce n'est pas non plus la solution la plus écologique ...

La consommation européenne de papier toilette augmente de près 4% chaque année !

- Chaque européen consomme en moyenne 13 kilos de papier toilette chaque année, soit 22 milliards de rouleaux de papier / an.

- Pour produire un kilo de papier il faut environ 2,7 kilos de bois, 300 litres d'eau, et de nombreux produits chimiques,..., sans compter la quantité d'énergie nécessaire.

*(Source: WWF – le papier hygiénique: une réelle menace écologique !)*

La solution est souvent si simple que l'on peine à l'envisager, et pourtant, en remplaçant le papier toilette par de l'eau, le WC douche offre une hygiène parfaite, de nombreux bénéfices pour la santé et permet de participer efficacement à la protection de notre environnement

Imagineriez vous de vous laver quotidiennement les mains uniquement avec du papier ?

C'est pourtant ce que vous faites tous les jours pour votre hygiène intime !









# ABATTANTS WC LAVANTS

---

Télécommande déportée







Abattant lavant FRESH

Existe en taille standard



Abattant lavant SEDUCTION

Existe en 3 tailles

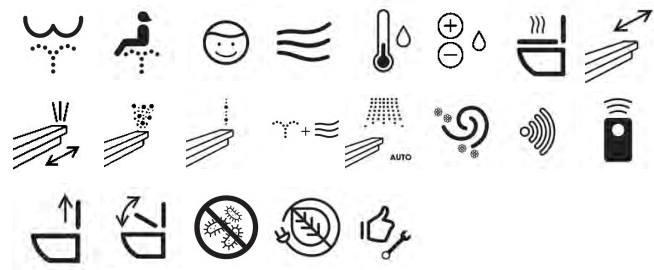

Abattant lavant PRIVILEGE

Existe en 3 tailles

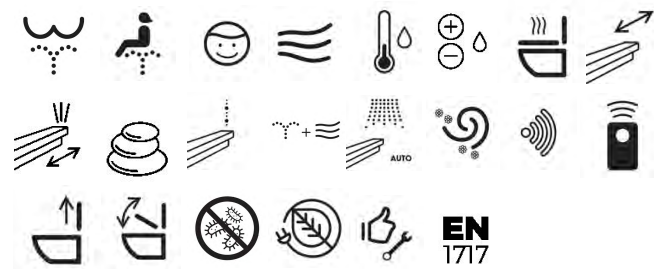

new  
2019



Abattant lavant EVIDENCE

Existe en 3 tailles

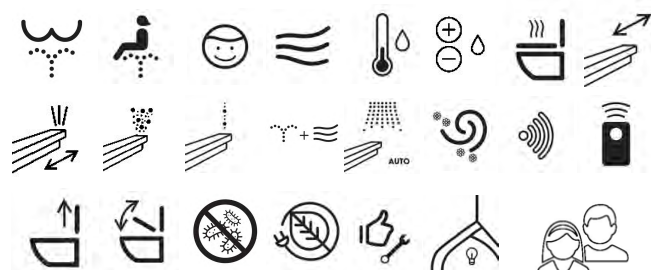



# WC JAPONAIS - AU SOL

---

Télécommande déportée



## WC Lavant au sol EXCELLENCE PLUS

---



Évacuation en sortie verticale ou horizontale  
Nécessite :

- une pression de 2.5 bars minimum
- un débit d'eau de 15 litres/mn

## WC Lavant au sol SENSATION

---



Évacuation en sortie verticale ou horizontale  
Nécessite :

- une pression de 2.5 bars minimum
- un débit d'eau de 15 litres/mn

Ouverture et fermeture **Automatique** du couvercle et de la lunette







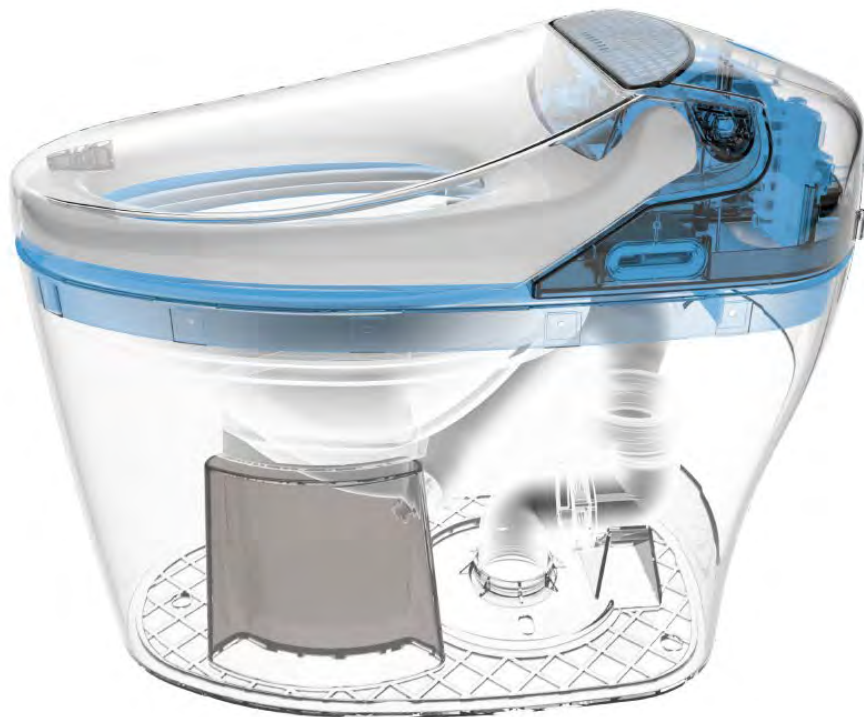
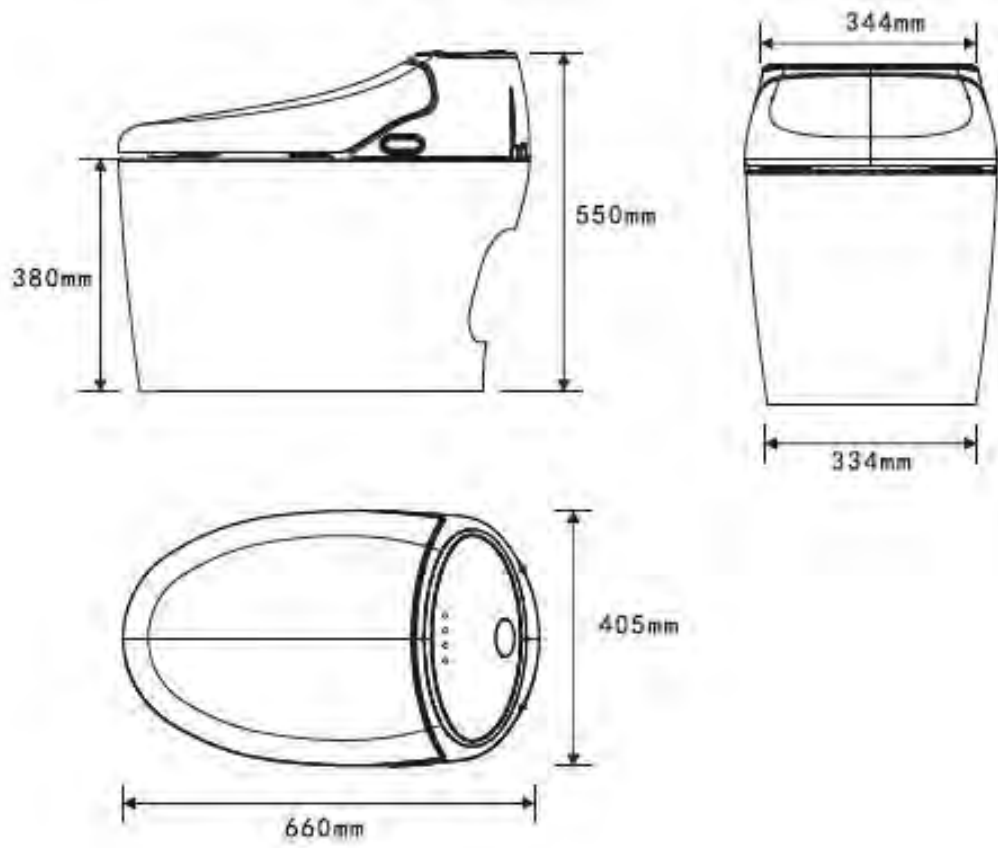





# WC JAPONAIS - SUSPENDUS

---

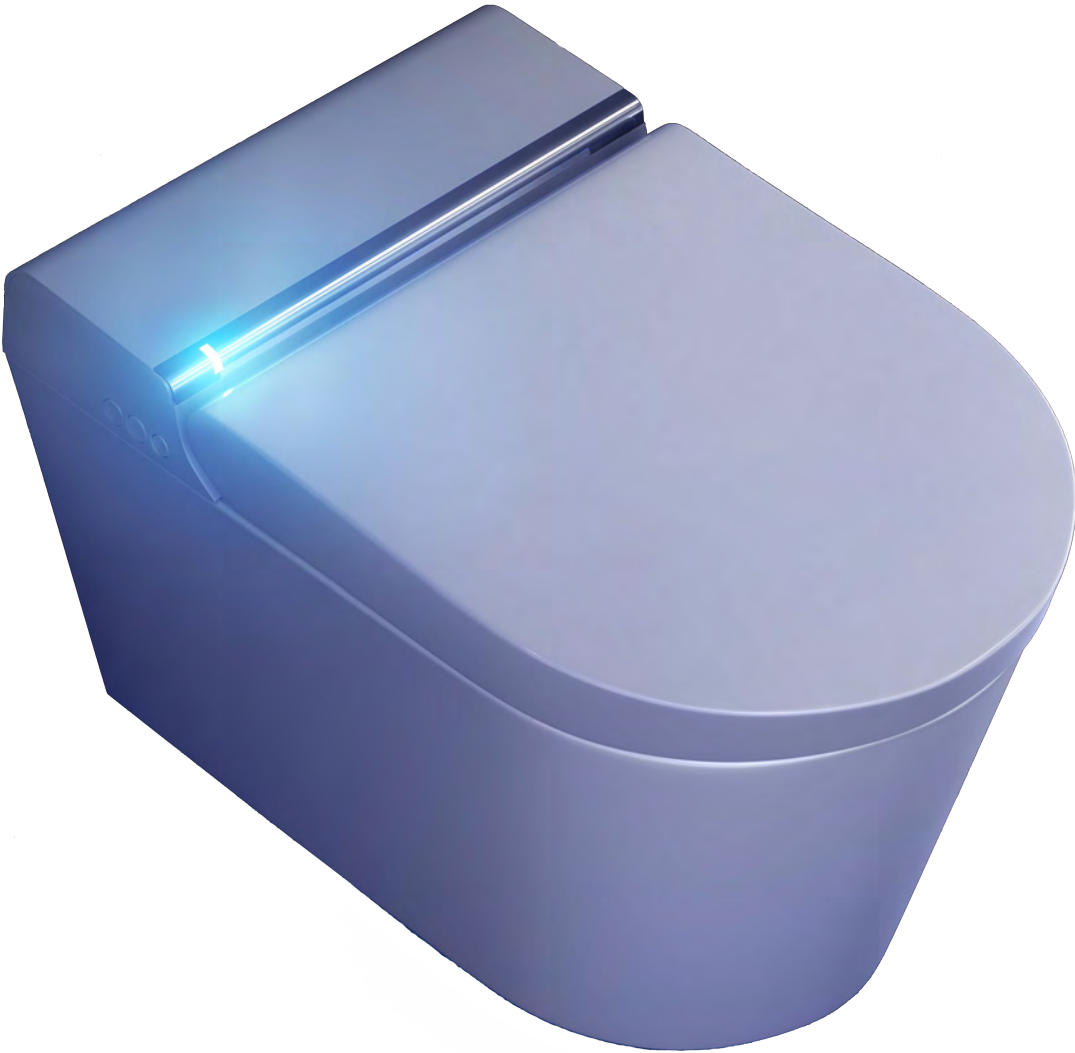















WC lavant suspendu COCOON

**COCOON**

Cuvette sans bride avec abattant lavant intégré

**COCOON+**

Cuvette sans bride avec abattant lavant intégré  
et Bâti Chasse NF

*Existe en 4 couleurs et 2 finitions :*

*Blanc brillant, Blanc Mat, Sable, Noir brillant, Noir  
Mat et Bleu pétrole Mat*







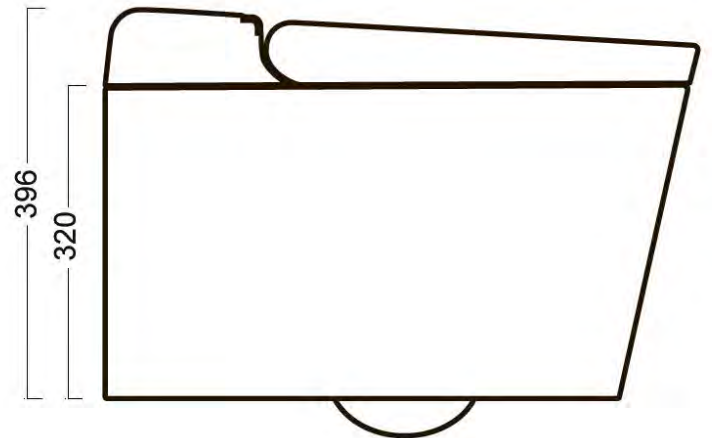
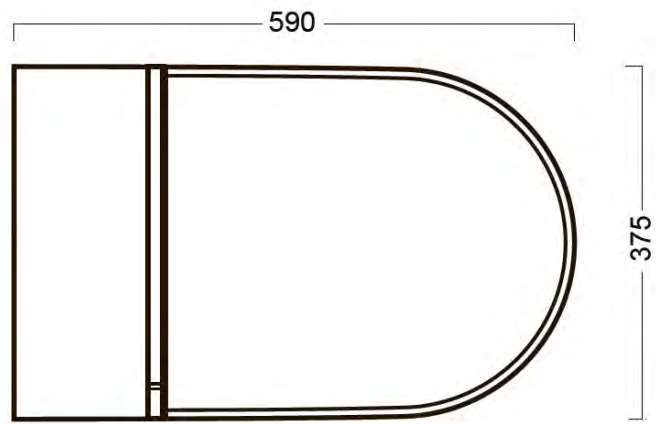
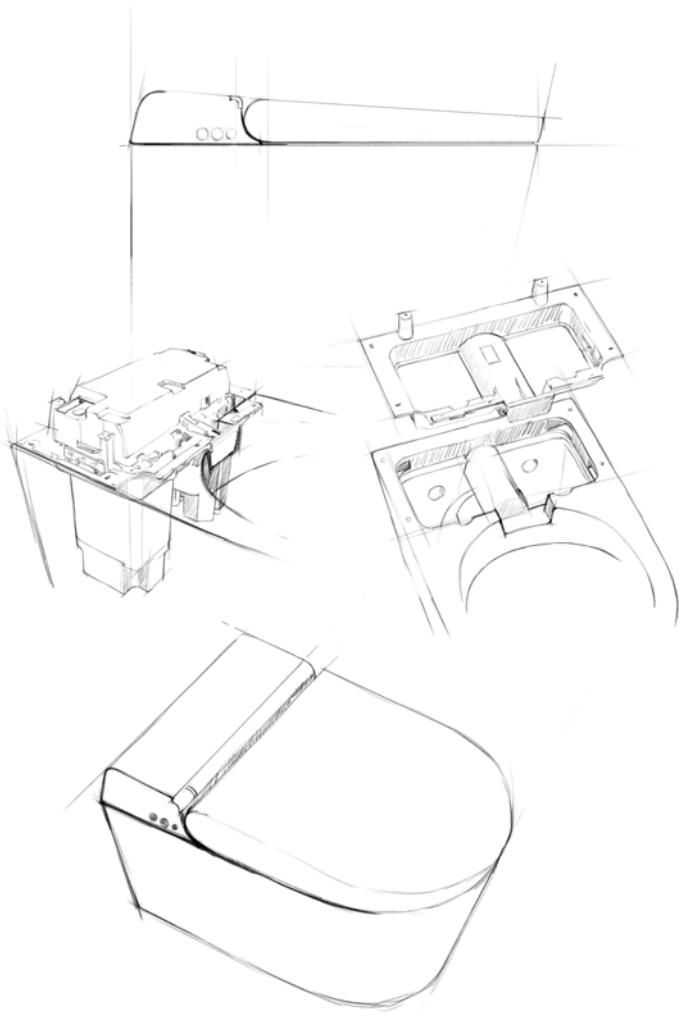





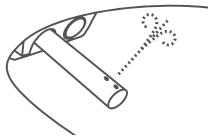

LAVAGE ANAL

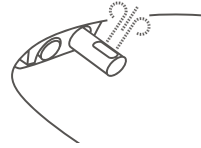

SECHAGE 2 intensités  
5 niveaux de température

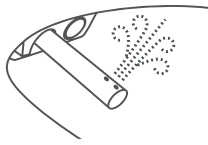

LAVAGE FEMININ



MEMORISATION UTILISATEUR : 2

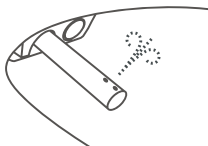

FONCTION ENFANT



LUMIERE D'AMBIANCE

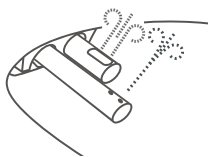

FONCTION "AUTO"  
(lavage + séchage)

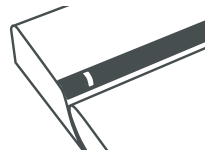

LUMIERE LED

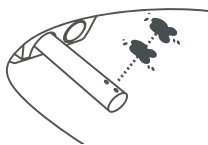

SPRAY PAR PULSATION



TELECOMMANDE

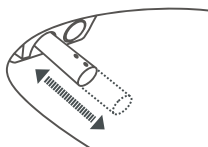

POSITIONNEMENT DOUCHETTE



PROGRAMME ANTI-CALCAIRE

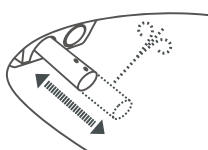

OSCILLATION DOUCHETTE

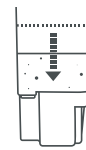

VIDANGE  
AUTOMATIQUE DU  
RESERVOIR

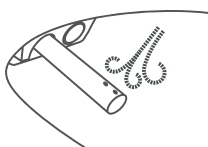

NETTOYAGE AUTOMATIQUE



CAPTEUR DE PRESENCE

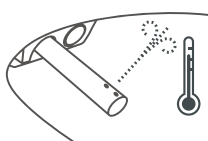

TEMPERATURE D'EAU  
REGLABLE

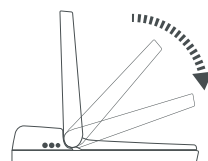

DESCENTE ASSISTEE



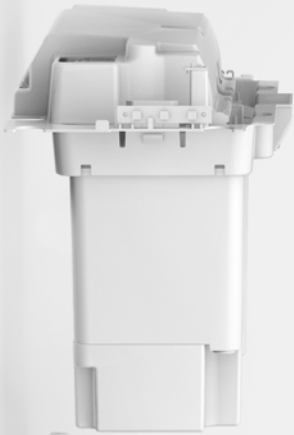

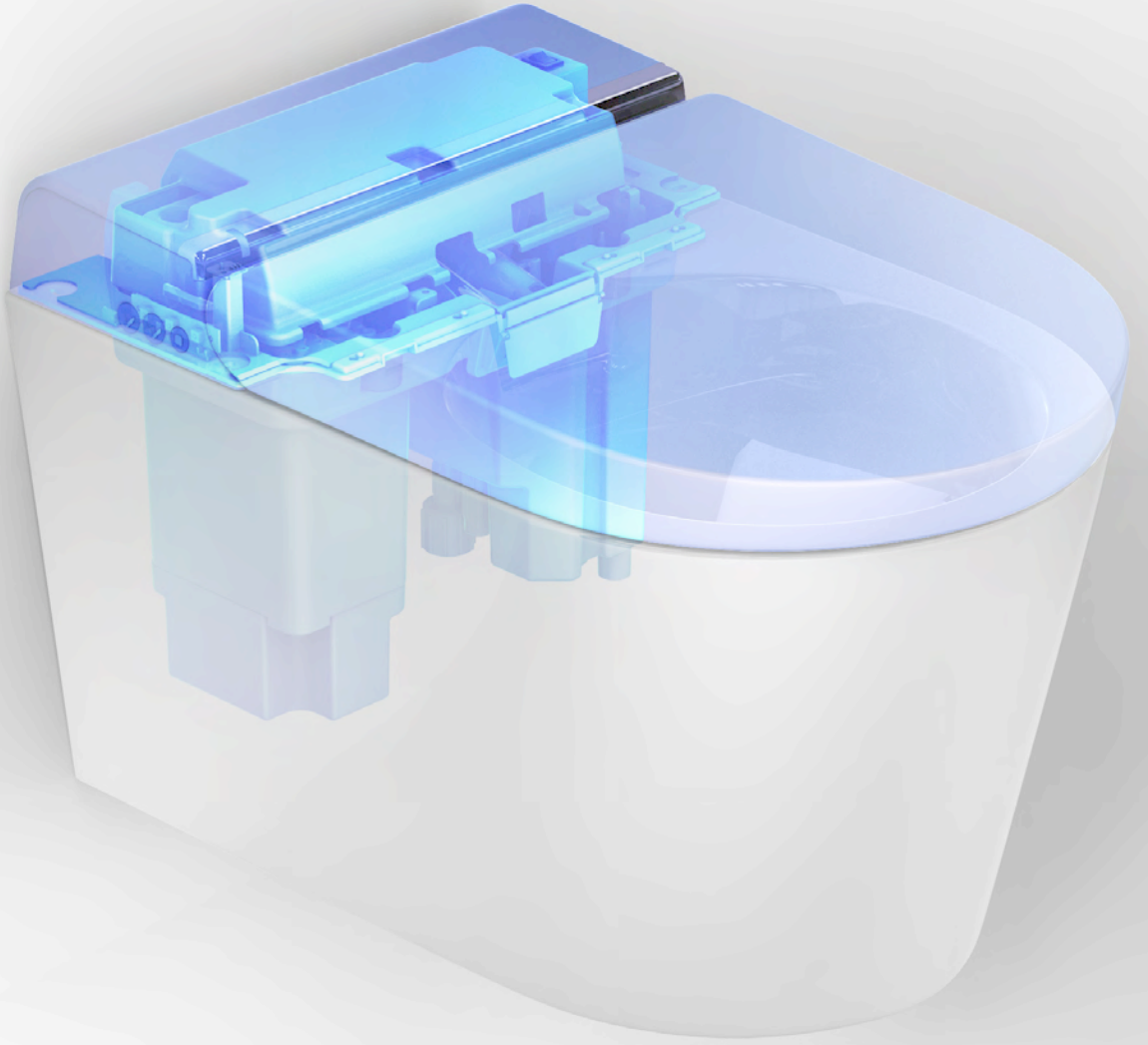









# KIT DOUCHETTE HYGIENE WC

---



## Kit douchette complet SANI200

---

- Douchette LAITON
- Flexible haute qualité PVC lisse argenté 1.25 m
- Support douchette en zamac chromé
- Vanne 3 voies LAITON - filetage 1/2 M x 3/8 F x 3/8 M avec bouton de fermeture

*Existe en Douchette seule + support - réf SANI300*

## Kit douchette complet SANI400

---

- Douchette LAITON - forme carrée
- Flexible haute qualité PVC lisse argenté 1.25 m
- Support douchette en zamac chromé
- Vanne 3 voies LAITON - filetage 1/2 M x 3/8 F x 3/8 M avec bouton de fermeture

*Existe en Douchette seule + support - réf SANI500*

## Kit douchette complet SANIDESIGN

---

- Douchette ABS chromé - longue
- Flexible Double Agrafage chromé 1.25 m
- Support douchette en ABS chromé
- Vanne 3 voies LAITON - filetage 1/2 M x 3/8 F x 3/8 M avec bouton de fermeture

*Existe en Douchette seule + support - réf SANIDD*

## Kit douchette complet SANIECOPLUS

---

- Douchette ABS chromé
- Flexible Double Agrafage chromé 1.25 m
- Support douchette en ABS chromé
- Vanne 3 voies LAITON - filetage 1/2 M x 3/8 F x 3/8 M avec bouton de fermeture

## Kit douchette complet SANIECO

---

- Douchette ABS Blanc
- Flexible nylon renforcé Blanc 1.25 m
- Support douchette en ABS blanc
- Vanne 3 voies LAITON - filetage 1/2 M x 3/8 F x 3/8 M avec bouton de fermeture

## Douchette japonaise SANI100

Douchette japonaise rétractable à installer sur votre cuvette actuelle.  
5 niveaux de pression.  
Commande par molette latérale.

*Composition du Kit :*

- Douchette
- Tuyau de raccordement en eau
- T de branchement sur la chasse d'eau
- Adhésifs 3M

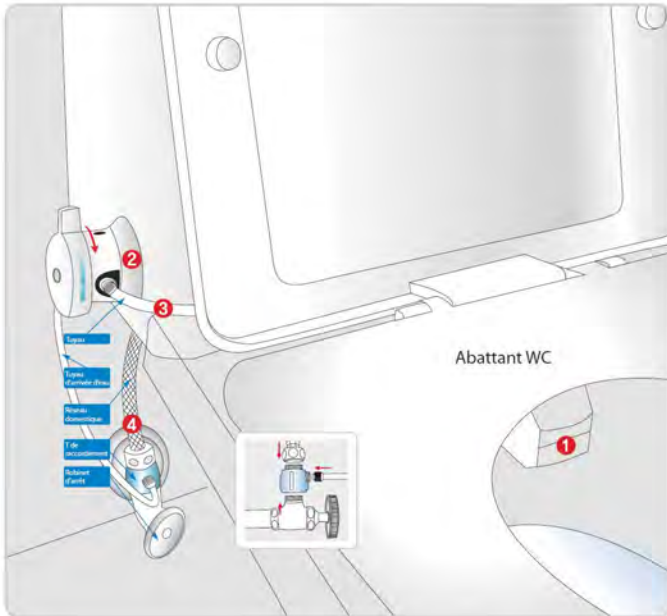





# ADAPATIBILITES - ABATTANTS LAVANTS

## Step 00

1 - Vérifier qu'aucune surélévation ne vient raccourcir l'espace disponible pour le positionnement de l'abattant

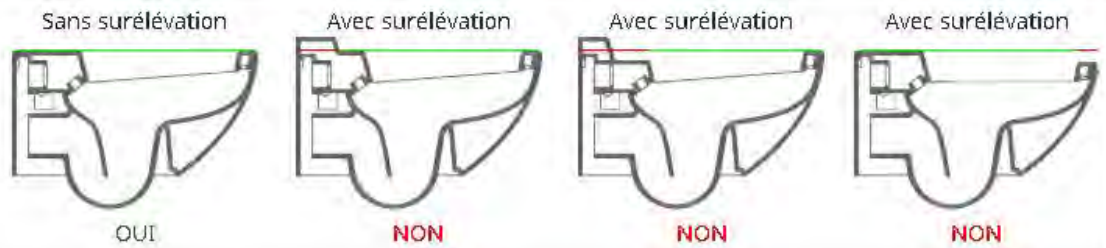

## Step 01

2 - Vérifier laquelle de ces formes correspond le plus à vos sanitaires:



Standard



Allongé



Carré

## Step 02

3 - Vérifier les dimensions suivantes:

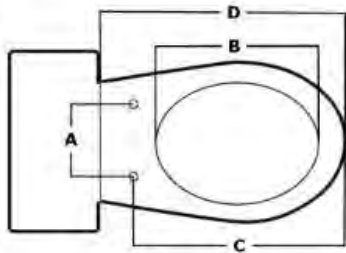

A = de 14 à 24 cm  
B = au moins 31 cm  
C = de 40 à 45 cm  
D = au moins 49 cm

Standard

A = de 14 à 24 cm  
B = au moins 34 cm  
C = de 43 à 48 cm  
D = au moins 52 cm

Allongé

A = de 14 à 24 cm  
B = au moins 32 cm  
C = de 41 à 46 cm  
D = au moins 50 cm

Carré

## Step 03

4 - Il est également possible de télécharger un gabarit papier à imprimer (réglage imprimante: conserver les proportions), puis couper et assembler pour essayer sur vos toilettes

Télécharger le gabarit  
déclinaison **standard**

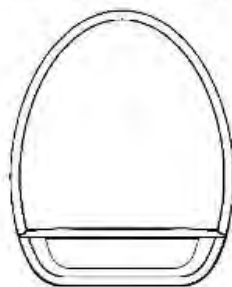

Télécharger le gabarit  
déclinaison **allongé**

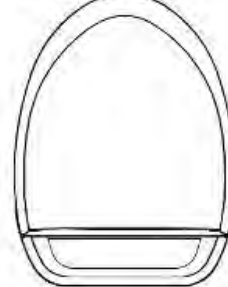

Télécharger le gabarit  
déclinaison **carré**

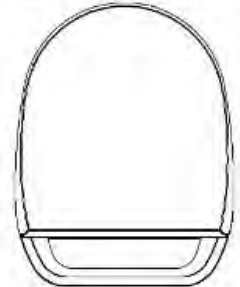

# LEGENDE

---



Lavage anal



Télécommande



Ouv./fermeture  
Automatique



Lavage féminin

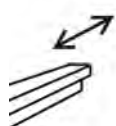

Position douchette  
réglable



Éco.d'énergie



Lavage enfant



Oscillation  
douchette



Déclipsable



Séchage



Rinçage automatique  
des douchettes



Descente assistée



Lunette chauffante



IIP- Jet pulsation



Traitement  
anti-bactérien



Eau chaude réglable



Jet d'eau aéré

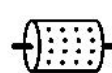

Filtre  
anti-impureté

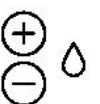

Pression réglable



Sitz Bath - SPA



Norme EN1717

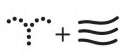

Fonction Auto



Lumière d'ambiance



Installation facile



Désodorisation



Mémorisation utilisateurs : 2



Capteur de présence



Chasse d'eau automatique



Commande latérale



Saniclean®  
*Simplify Your Life*

## SANICLEAN

22 avenue Ferdinand de Lesseps  
33610 CANEJAN  
France

Tél. 05 56 81 56 72  
Fax. 05 56 81 57 09  
info@saniclean.fr

[www.saniclean.fr](http://www.saniclean.fr)

-SHOWROOM- Canéjan (33)



*Société française*